

38368 38229

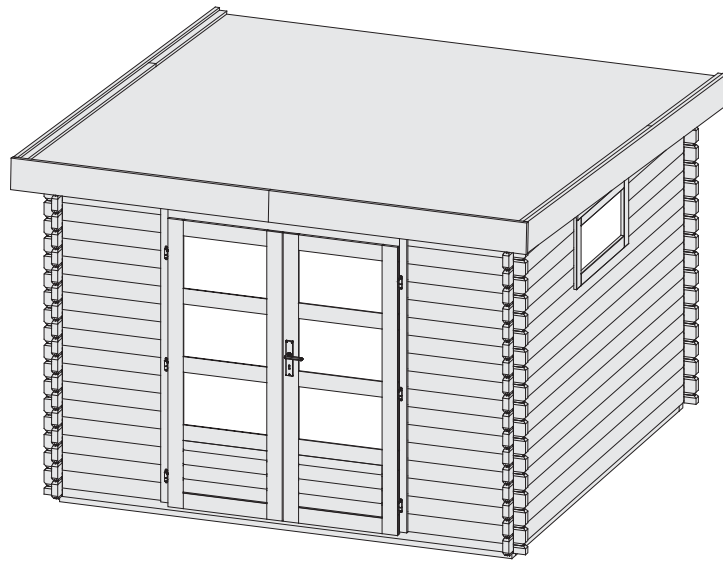

-  **Aufbauanleitung**
-  **Building Instructions**
-  **notice de montage**
-  **montagehandleiding**
-  **Montagevejledning**
-  **Instrucciones de construcción**
-  **Istruzioni per il montaggio**
-  **Montážní návod**

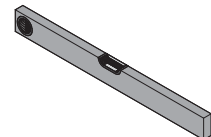
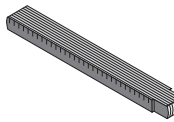
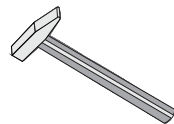
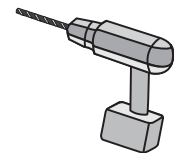
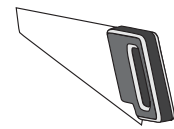

Werkzeuge / Tools*

X

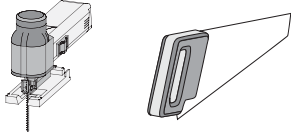

X

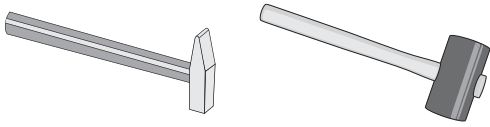

X

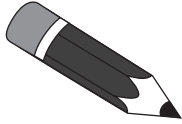

X

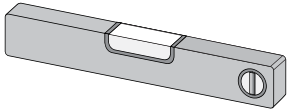

X

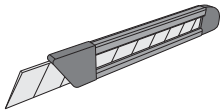

X

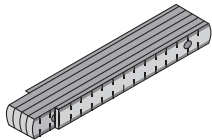

X

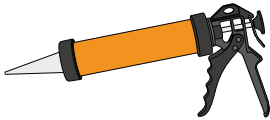

X

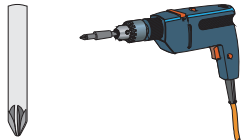

X

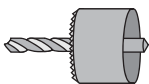
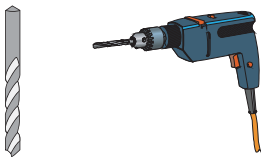

X

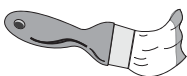

X







Bitte bewahren Sie die Anleitung und den Garantieschein zur Seriennummer auf.





Vernichten Sie diese erst nach Ablauf der Garantiezeit.





Eventuelle Beanstandungen können mithilfe der Stückliste einfacher zugeordnet werden.





Beigelegte Dokumente

- Informationsheft
- Garantieschein zur Seriennummer
- Typenschild inkl. Warnhinweise (Sauna)
- ggf. Zubehör-Anleitungen in externen Paketen





- *  Nicht im Lieferumfang enthalten
 Not included
 Non comprises dans la livraison
 Niet bijgeleverd

-  No forman parte del suministro
 Non incluso
 V ceně není zahrnuto
 Ikke inkluderet

- 1  Länge muss ermittelt und zugesägt werden
 Length must be determined and sawn
 La longueur doit être déterminée et sciée
 De lengte moet worden bepaald en worden gezaagd

-  La longitud debe ser determinada y aserrada
 La lunghezza deve essere determinata e segata
 Délka musí být určena a rozřezána
 Længden skal bestemmes og saves





- 2  Nicht gebraucht
 Not needed
 Pas nécessaire
 Niet nodig

-  No es necesario
 Non necessario
 Není nutná
 Ikke nødvendigt





- 3  Mit Zubehör
 With accessories
 Avec accessoires
 Met toebehoren

-  Con accesorios
 Con accessori
 S příslušenstvím
 Med tilbehør

- 4  Fixiert vorübergehend
 Fixed temporarily
 Temporairement fixe
 Tijdelijk vast

-  Temporalmente fijo
 Temporaneamente fisso
 Dočasně pevný
 Midlertidigt rettet

- 5  Bestand vom Haus
 Inventory of the house
 Inventaire de la maison
 Inventaris van het huis

-  Inventario de la casa
 Inventario della casa
 Inventář domu
 Inventar af huset



Vergleichen Sie zuerst die Material-liste mit Ihrem Paketinhalt! Bitte haben Sie Verständnis, dass Beanstandungen nur im nicht aufgebauten Zustand bearbeitet werden können!



Vergelijk eerst de lijst van materialen met de inhoud van uw pakket! Reclamaties kunnen alleen in behandeling worden genomen zolang de onderdelen nog niet zijn gemonteerd!



Confrontate questa distinta materiali prima con il contenuto del pacchetto! Vi preghiamo di comprendere che eventuali reclami possono essere accolti solo prima del montaggio!



First compare the list of materials with your package contents! Please understand that complaints can be processed in the non-built status only!



Start med at kontrollere materialelisten med indholdet af den leverede pakke! Vi gør venligst opmærksom på at reklamationer kun kan behandles for materialer som ikke er blevet bearbejdet!



Nejprve překontrolujte obsah balení podle materiálového listu! Mějte pochopení pro to, že případnou reklamaci se můžeme zabývat pouze tehdy, když díly nebudou smontované! Za pomoci tohoto seznamu můžete jednotlivé díly přiřadit k montážnímu návodu.



Commencez par comparer la liste du matériel avec le contenu de votre paquet! Sachez que nous traitons uniquement les réclamations concernant le matériel à l'état non monté!



En primer lugar, compare la lista de material con el contenido del paquete. Rogamos entienda que las reclamaciones sólo pueden ser tramitadas antes de montar el objeto!

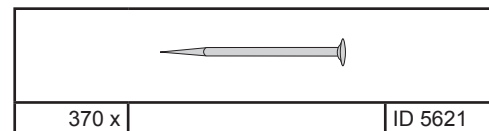
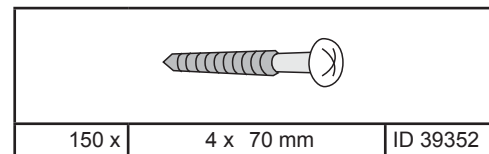
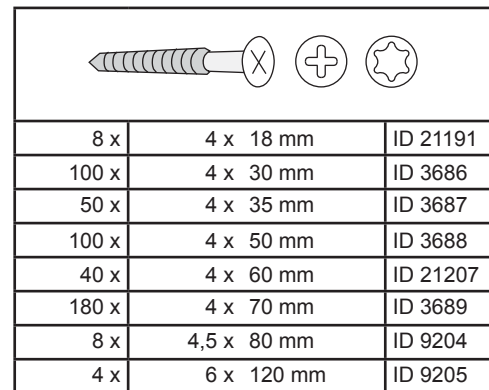
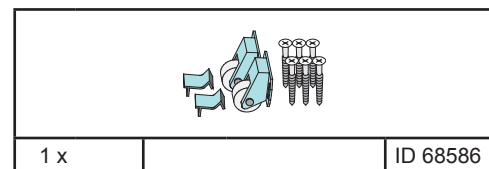
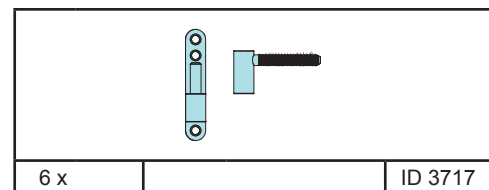
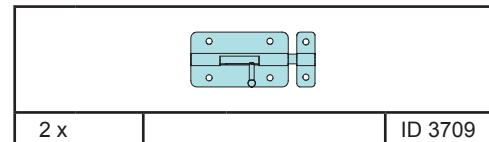
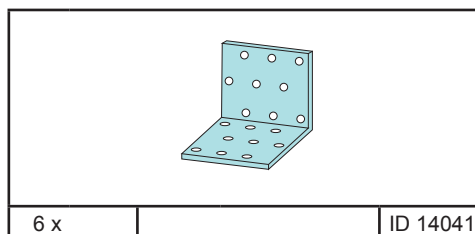
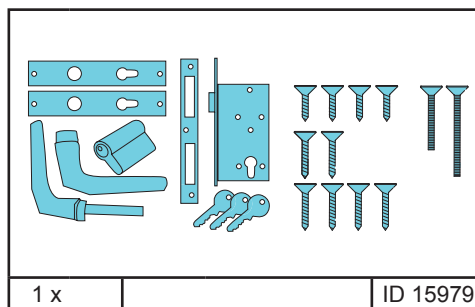
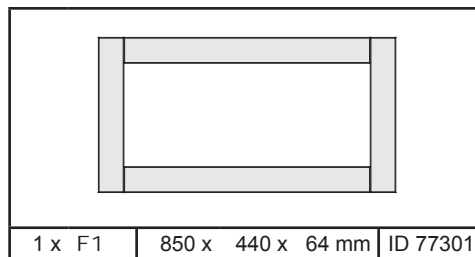
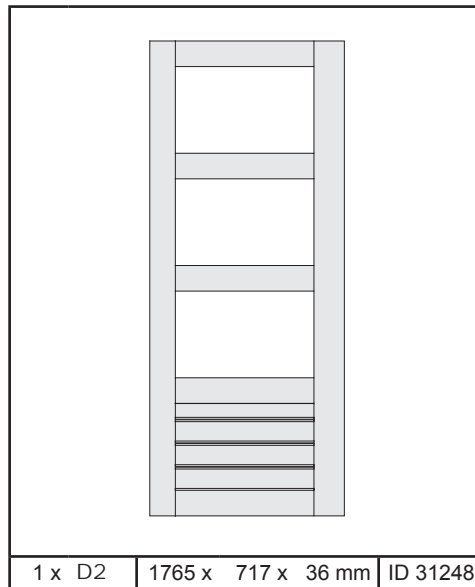
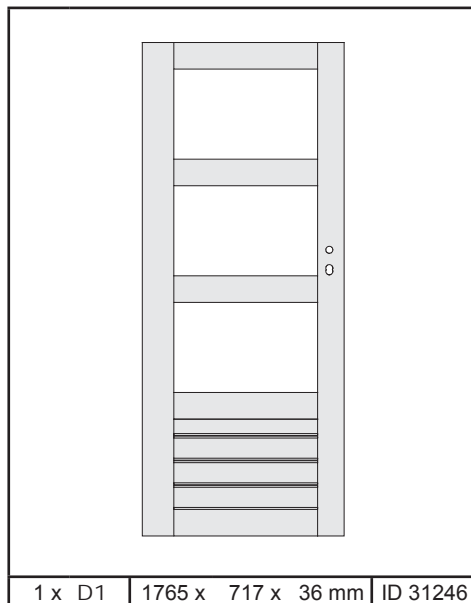
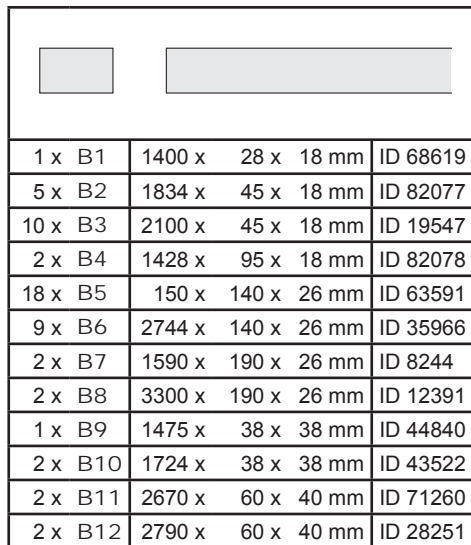
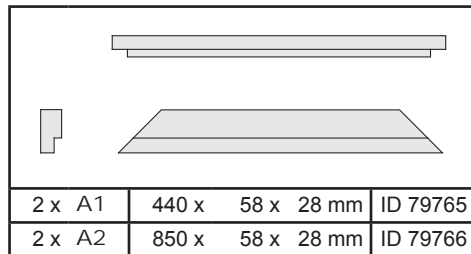
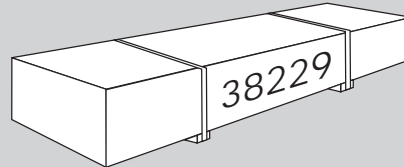
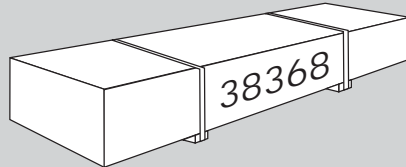

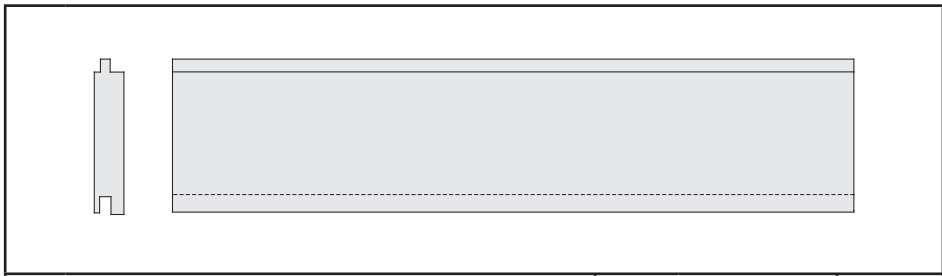

36 x R1 | 3300 x 96 x 19 mm | ID 19571

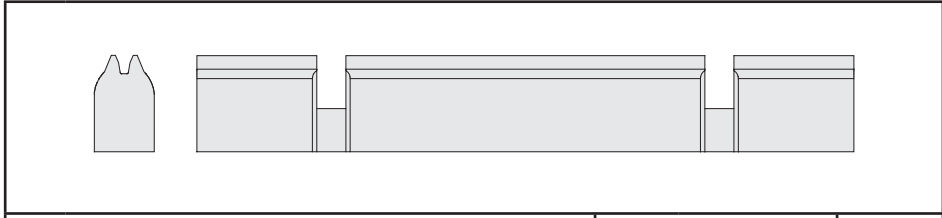

2 x W1 | 2970 x 71 x 38 mm | ID 35643

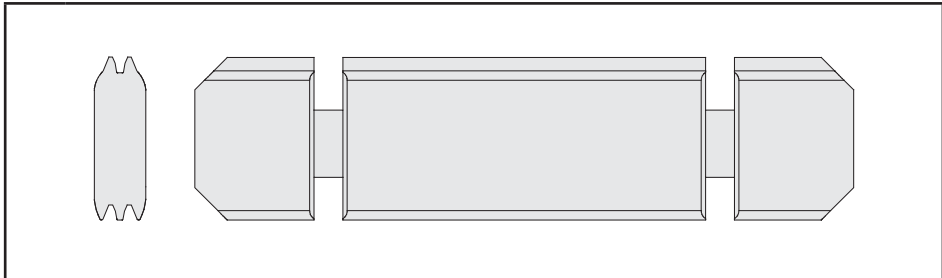

54 x W2 | 2970 x 121 x 38 mm | ID 29489

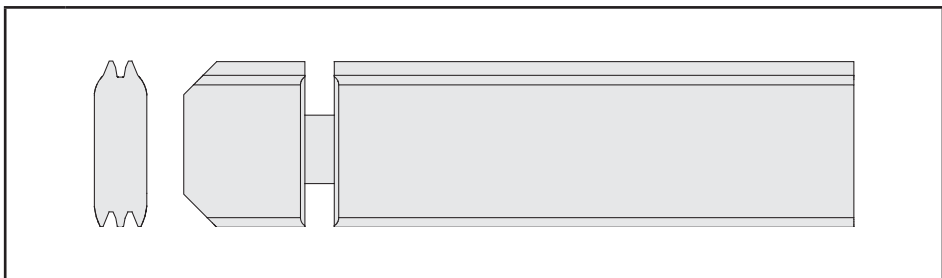

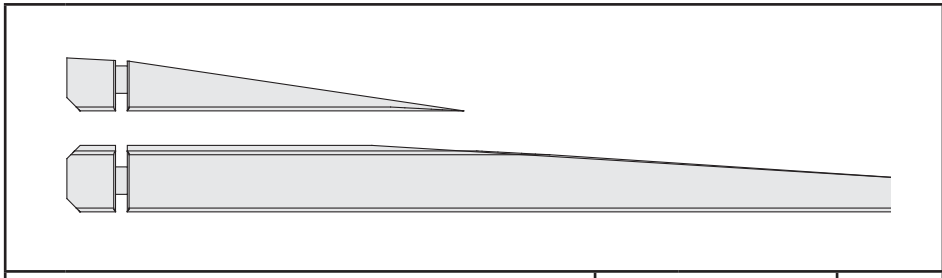

32 x W3 | 743 x 121 x 38 mm | ID 61757



2 x Z1 | 2970 x 212 x 38 mm | ID 78729

 Übersicht
 Overview
 enquête

 overzicht
 undersøgelse
 estudio

 sondaggio
 přehled

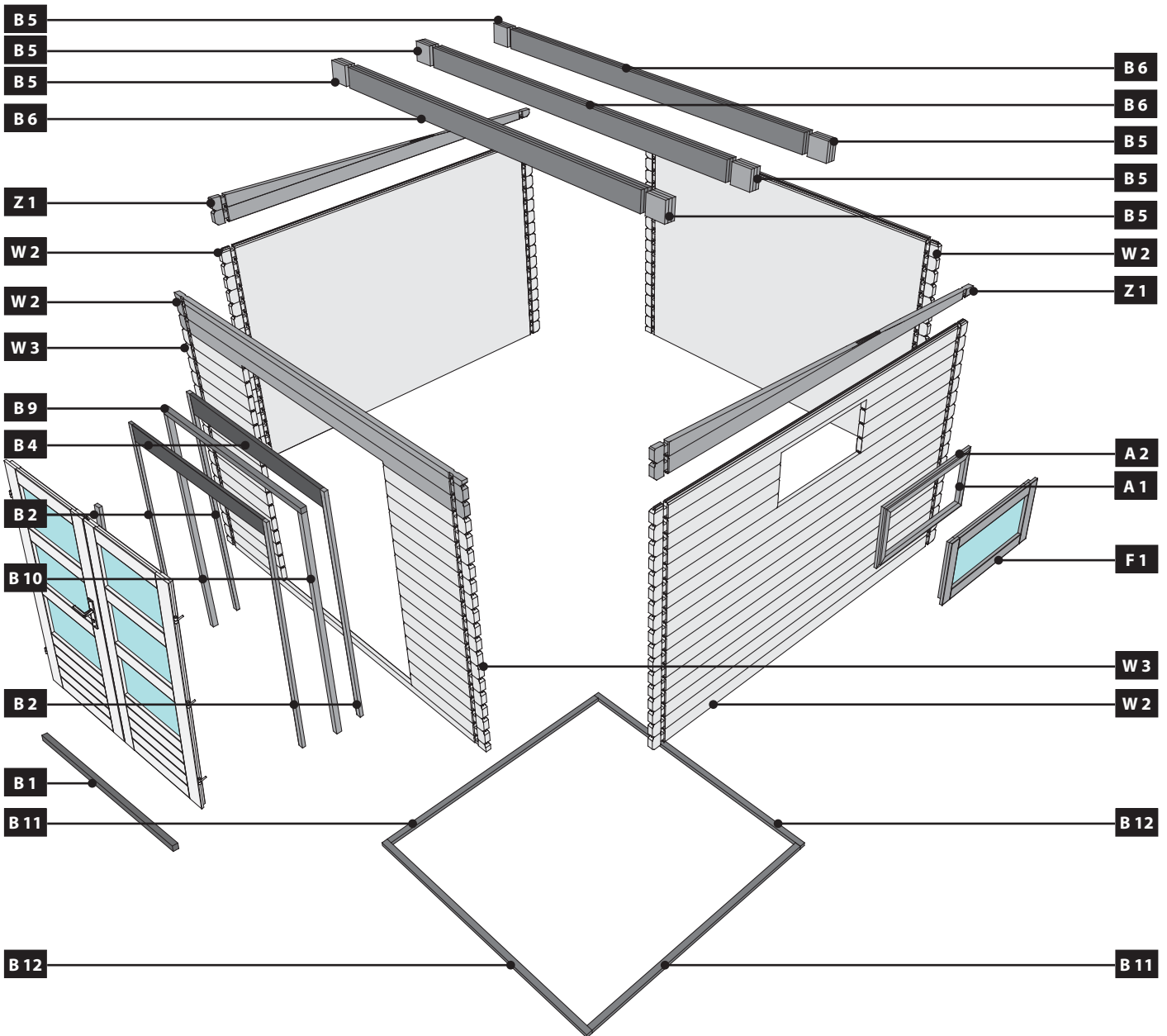
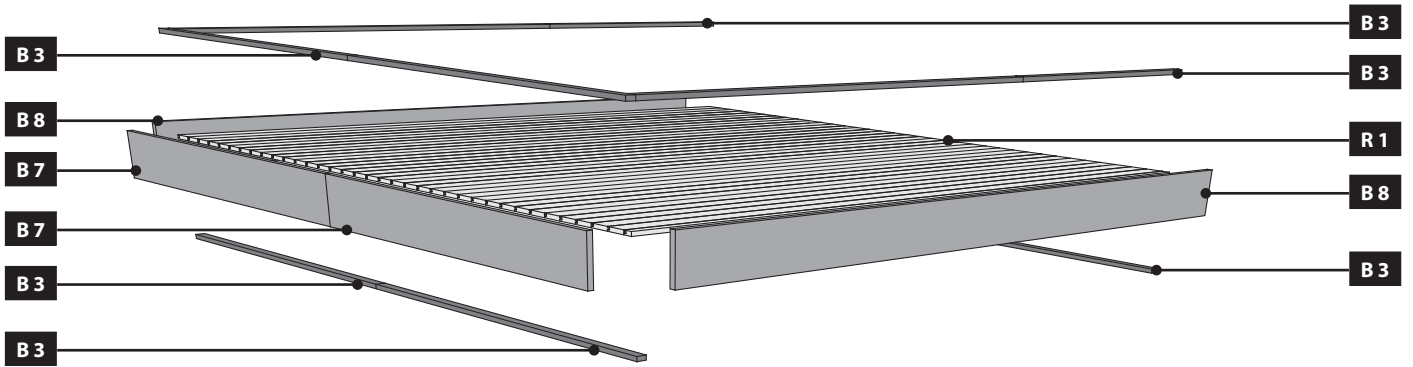

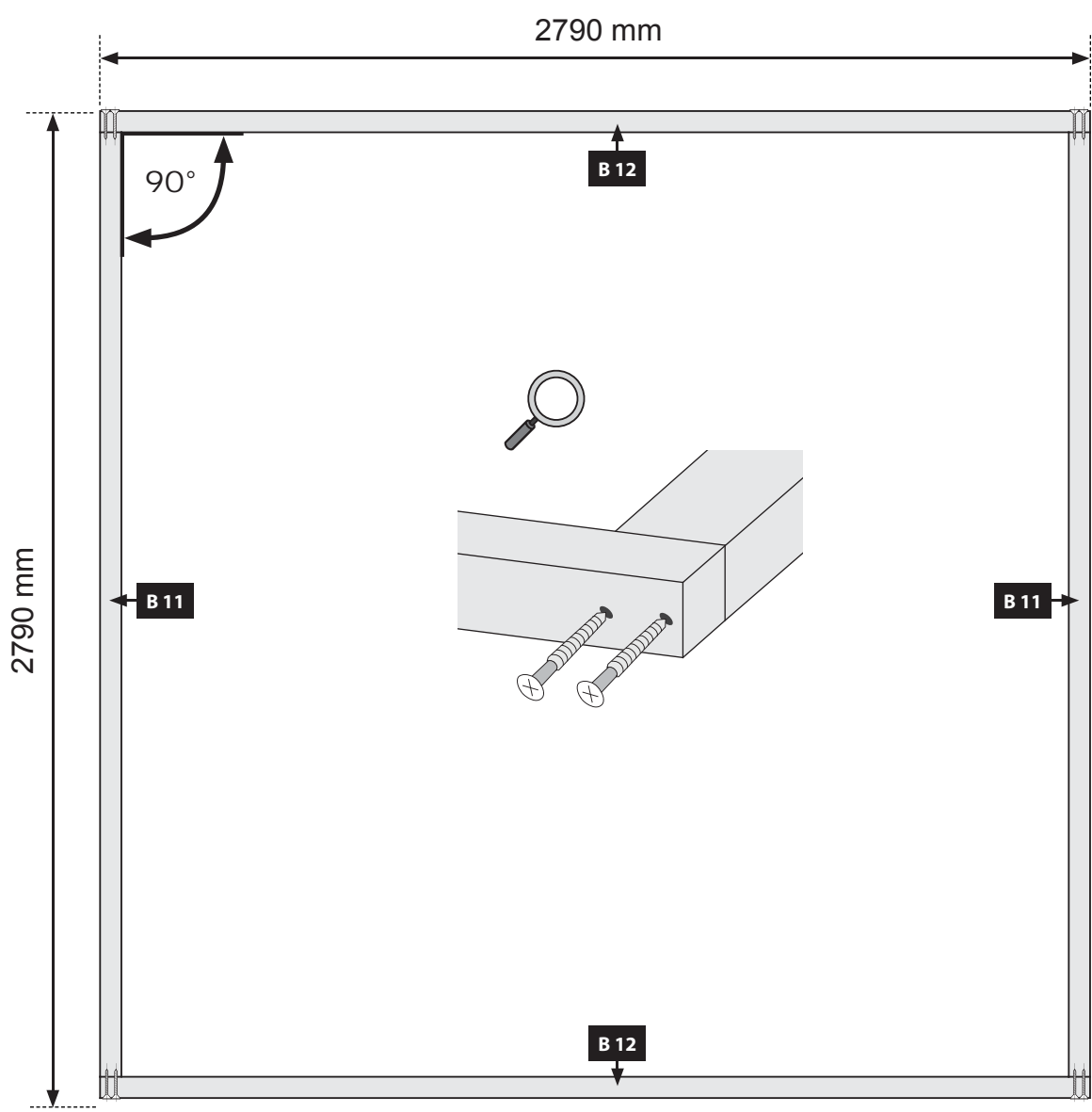
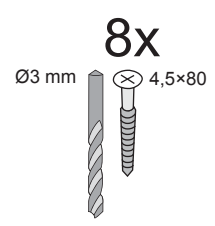
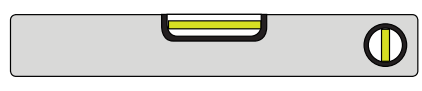

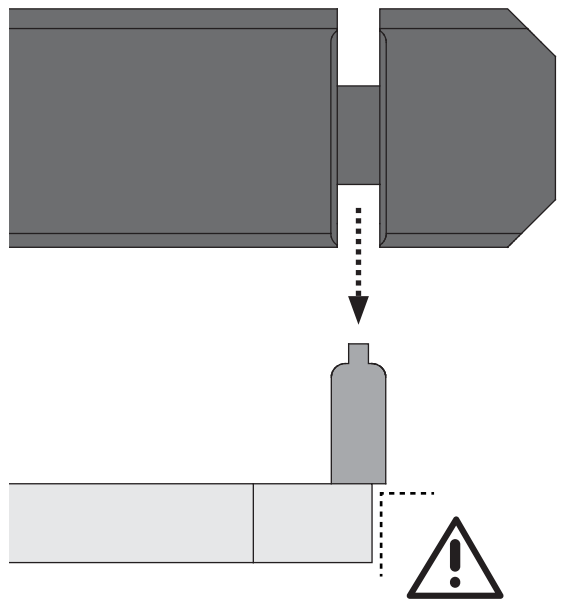
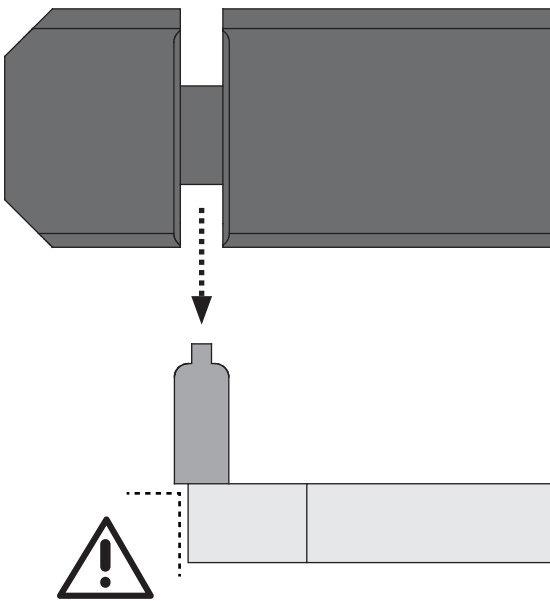
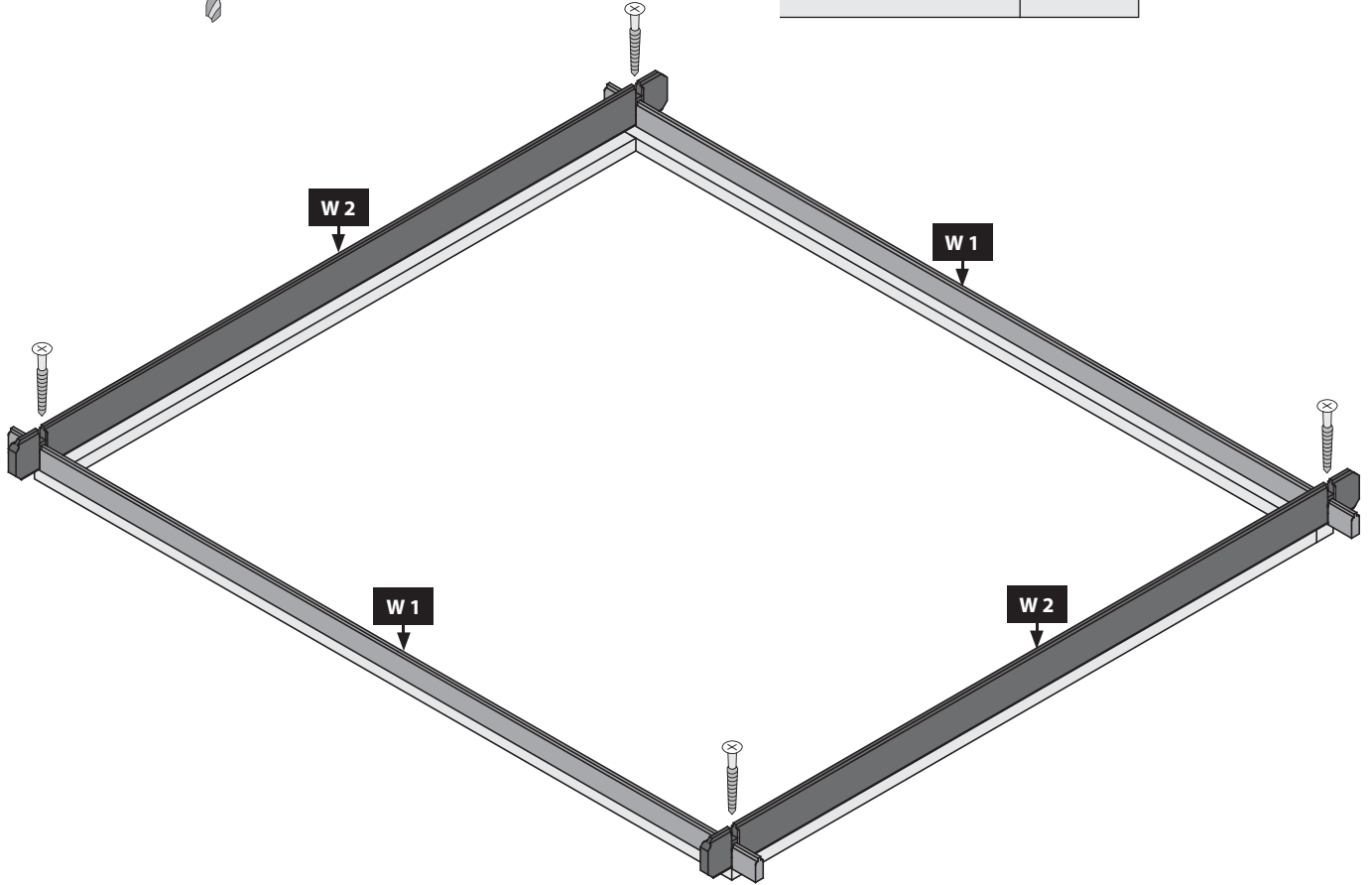
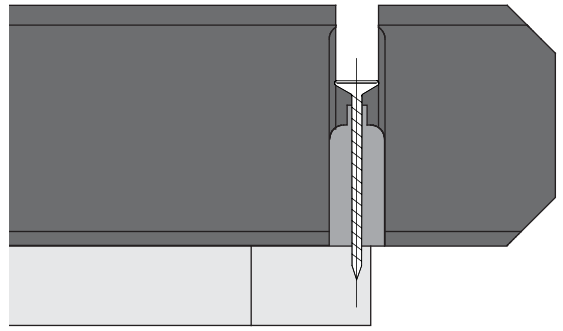
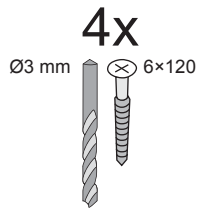

 Verschraubung Ausschnitte

 Cut-outs for screw connections

 Atornilladura recorte

 Vissage découpes

 Vastschroeven uitsparingen

 Fissaggio tavole

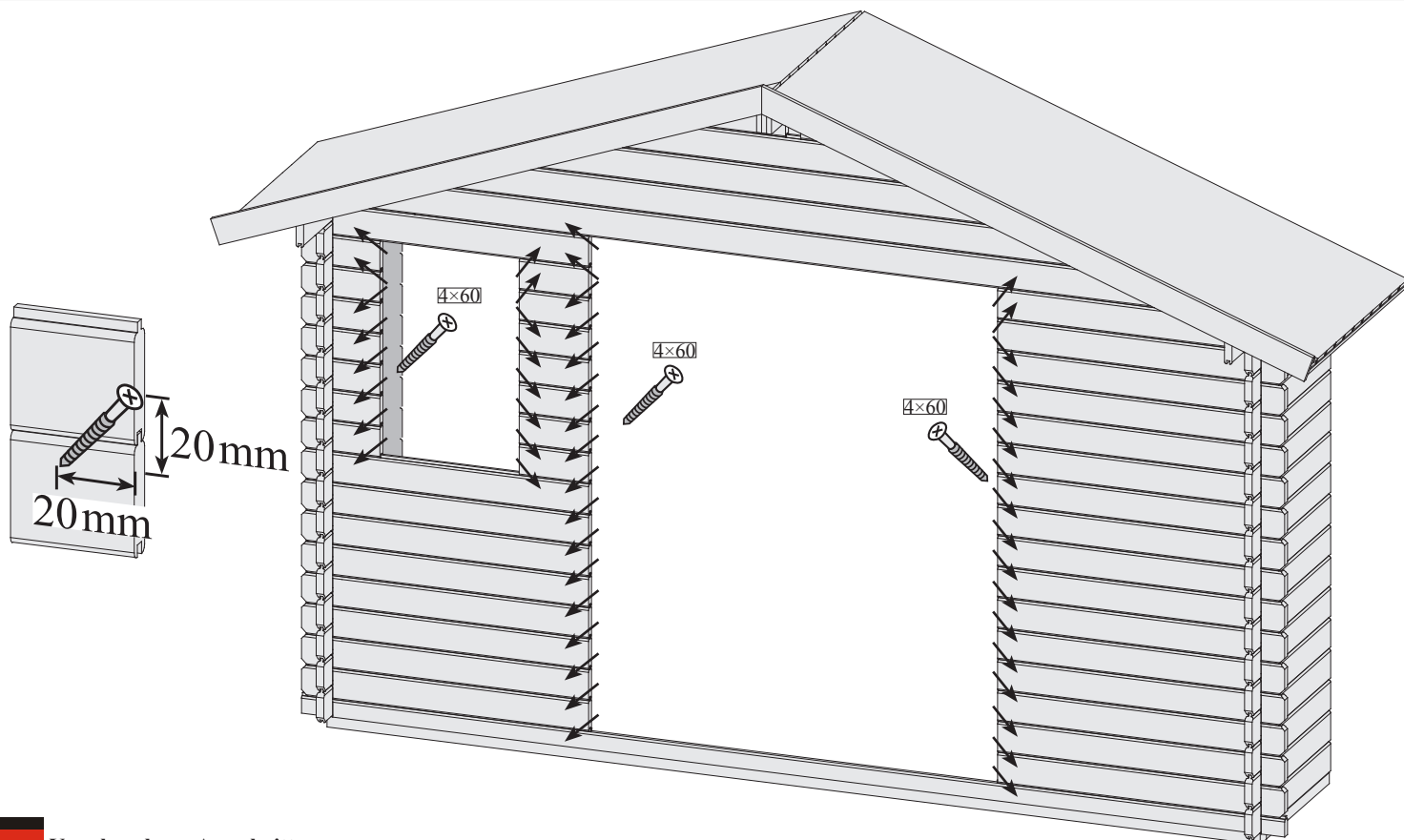

Verschraubung Ausschnitte

Holz hat ein natürliches Quell und Schwindverhalten. Dadurch „wächst“ und „schrumpft“ Ihr Haus im Laufe eines Jahres. Kürzere Holzbohlen (Front) passen sich schneller als längere Bohlen den aktuellen klimatischen Bedingungen an. Dadurch kann es zu Spaltenbildungen kommen. Um diese Spaltenbildung zu verringern aber gleichzeitig das natürliche Quell- und Schwindverhalten des Holzes zu gewährleisten müssen Sie an Fenster und Türausschnitten die jeweils zwei direkt übereinandersetzenen Bohlen miteinander verbinden. Verwenden Sie dafür Spax 4 x 60. Bohren Sie die Bohlen bei einer Verschraubung immer vor. **Hinweis:** Schräge Bohrungen ohne Abrutschen: Die ersten 3 bis 5mm den Bohrer senkrecht zur Holzoberfläche ansetzen und erst dann im gewünschten Winkel bohren.

Vissage découpes

Le bois a un comportement naturel de gonflement et de rétraction. C'est ainsi que votre pavillon «se gonfle» et «se rétracte» au cours d'une année. Les madriers de bois plus courts (façade) s'adaptent plus rapidement aux conditions climatiques que les madriers plus longs. Ceci peut entraîner des fentes. Pour réduire cette formation de fentes tout en garantissant que le bois puisse se comporter de manière naturelle, vous devez raccorder au niveau des fenêtres et des découpes de porte les deux madriers respectivement situés l'un sous l'autre. A cet effet, utilisez des Spax 4 x 60. Lors de vissages, veuillez toujours percer un trou préalable dans les madriers. **Remarque:** pour percer des trous inclinés sans déraper, veuillez tenir la perceuse de manière perpendiculaire lors des premiers 3-5 mm, puis percer ensuite dans l'angle souhaité.

Cut-outs for screw connections

Wood is subject to a natural process of swelling and contraction. For this reason, over the course of the year your house “grows” and “shrinks”. Shorter wooden boards (front) adapt faster than long boards to the momentary climatic conditions. This can result in cracking. In order to reduce this cracking and at the same time allow for the natural growth and shrinkage behaviour of the wood, at the window and door recesses you must join each two boards positioned directly over each other. For this purpose, use 4 x 60 Spax joints. Always pre-drill the boards for screw can drill obliquely into the wood without slipping connections. **Note:** You away by setting on the drill vertically for the first 3-5 mm and only then drilling obliquely.

Vastschroeven uitsparingen

Hout zet uit en krimpt van nature. Daardoor zal ook uw huisje in de loop van een jaar „uitzetten“ en „krimpen“. Kortere houten delen (front) passen zich sneller danlangere delen aan de verschillende klimatologische omstandigheden aan. Daardoor kunnen er zich spleten vormen. Om de vorming van deze spleten te verminderen, maar tegelijkertijd het natuurlijke uitzet- en krimpedrag van het hout te waarborgen, moet u bij raam- en deuruitsparingen telkens de twee direct boven elkaar bevindende delen met elkaar verbinden. Gebruik daarvoor spax-schroeven 4 x 60. Boor de delen bij het vastschroeven altijd voor. **Opmerking:** schuin boren in hout zonder weg te glijden gaat het beste door de eerste 3-5 mm de boor haaks op de oppervlakte van het hout te houden en pas daarna onder de gewenste hoek te boren.

Atornilladura recorte

La madera tiene un comportamiento natural de hinchamiento y encogimiento. Debido al mismo, su casa „crece“ y se „encoge“ a lo largo del año. Los tablones de madera cortos (parte delantera) se adaptan más rápido que los largos a las condiciones climatológicas. Para reducir esta formación de ranuras pero, al mismo tiempo, garantizar el proceso natural de hinchamiento y encogimiento de la madera, tiene que unir en la ventana y los recortes de la puerta entre sí los dos tableros que están justo uno sobre otro. Utilice para ello Spax 4 x 60. Perfore siempre previamente los tablones antes de efectuar el atornillamiento. **Advertencia:** Para efectuar perforaciones inclinadas en la madera sin resbalar hacer los primeros 3-5 mm con la broca vertical respecto a la superficie y después inclinar en el ángulo deseado.

Fissaggio tavole

È naturale che il legno lavori dilatandosi e restringendosi. Per questo la vostra casa „cresce“ e „si contrae“ nel corso dell'anno. Le assi più brevi (quelle frontali) si adattano alle situazioni climatiche più velocemente di quelle più lunghe. Per questo si può avere la formazione di crepe. Per minimizzare il rischio della formazione di crepe ma allo stesso tempo per permettere le contrazioni e dilatazioni del legno, sulle aperture della finestra e della porta collegare le due assi direttamente in contatto tra loro. Utilizzare a tal fine viti a croce da 4 x 60. Preforare sempre le assi prima di avvitare. **Avviso:** Per fare dei fori obliqui nel legno senza che la punta scivoli si può dapprima fare un foro perpendicolare per 3-5 mm e poi iniziare a forare con l'angolo desiderato.

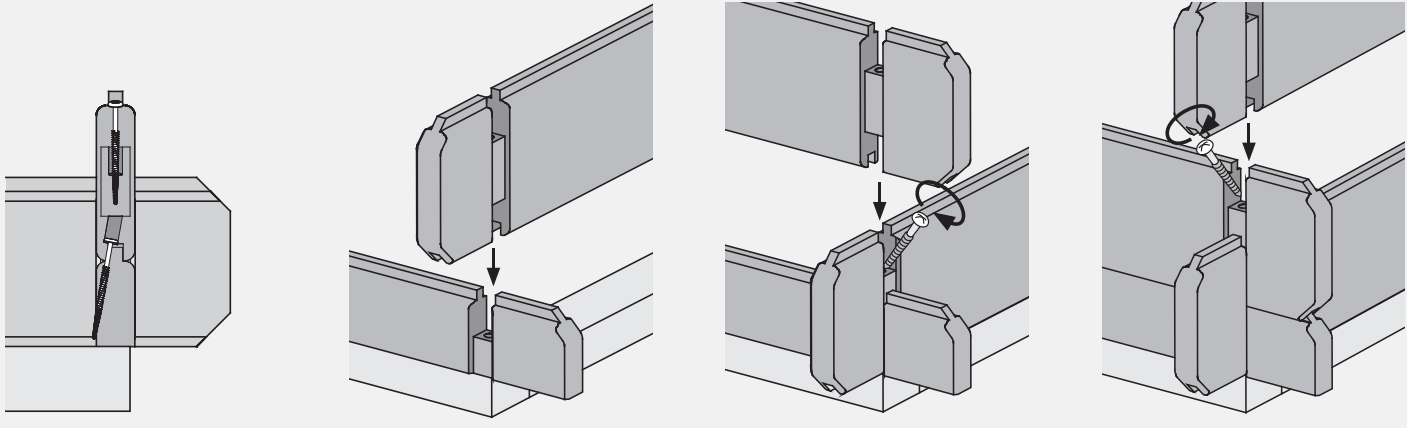

132x

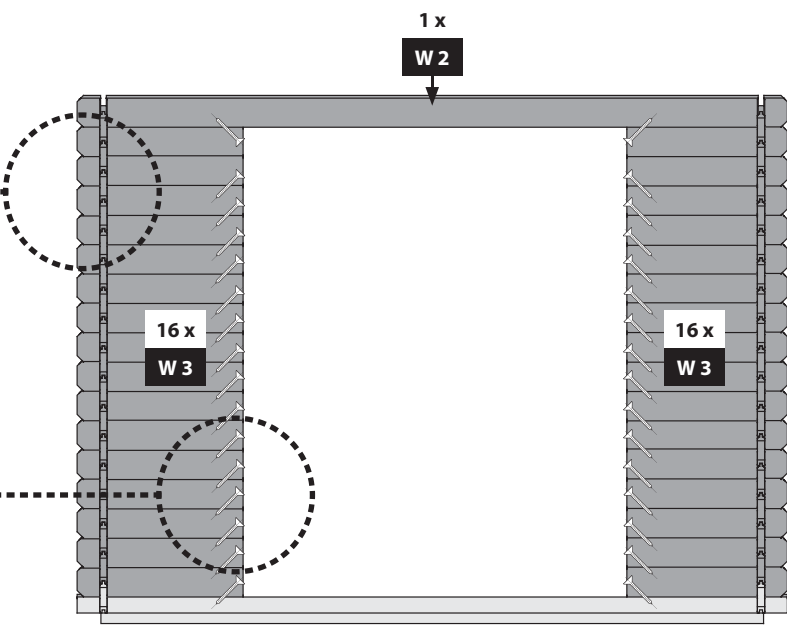
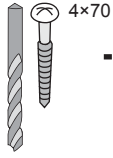

32x

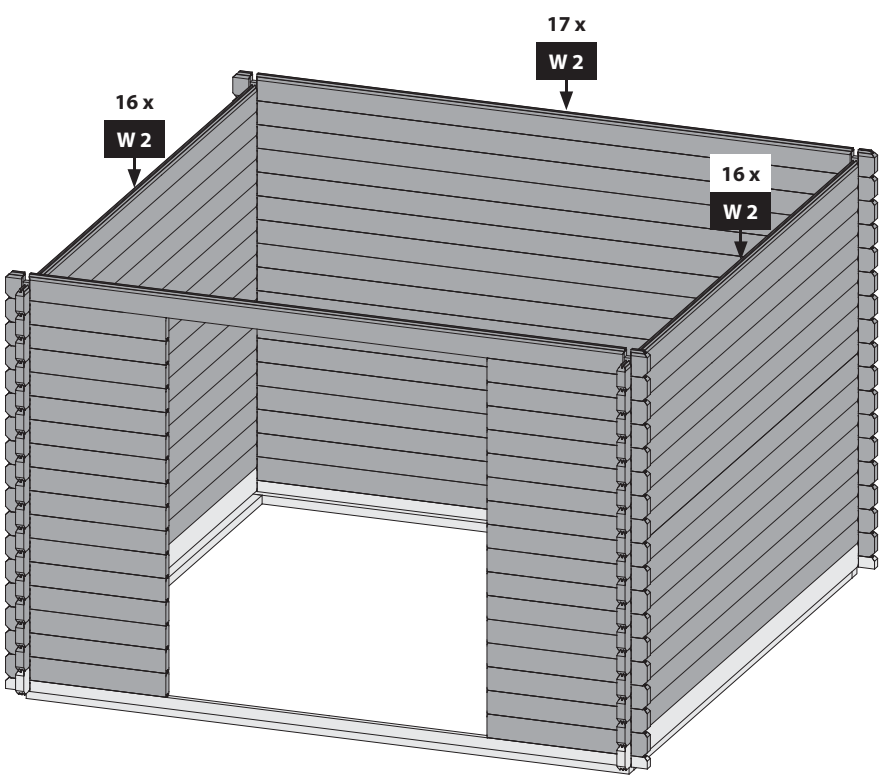
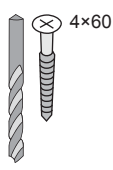

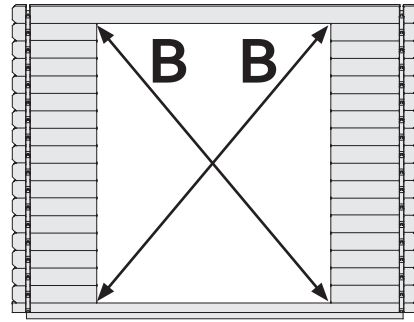
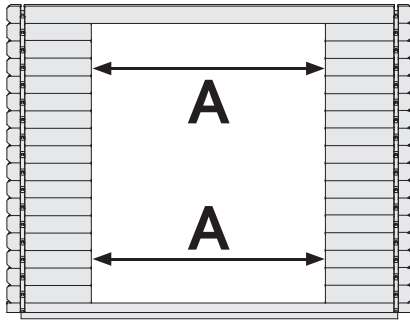

04

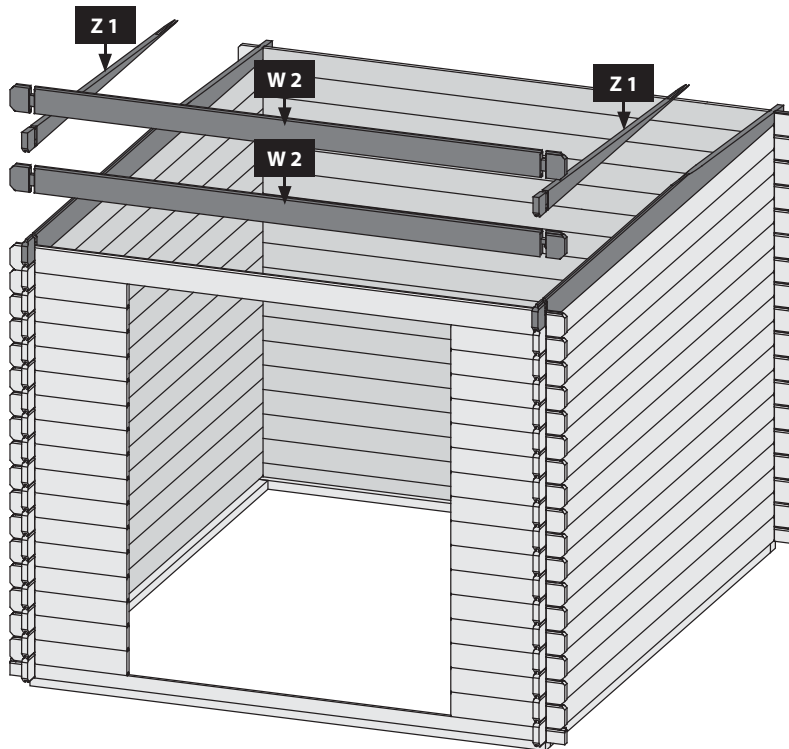

10x

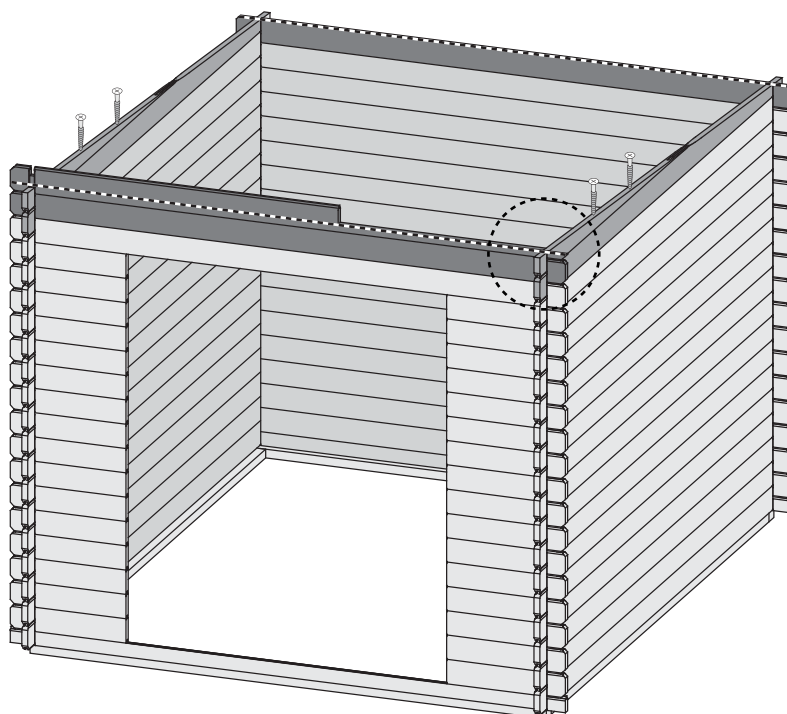
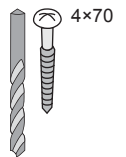

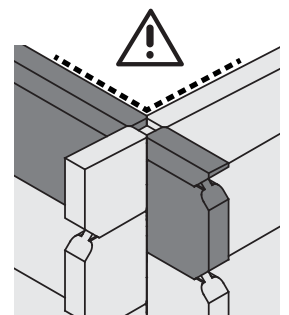
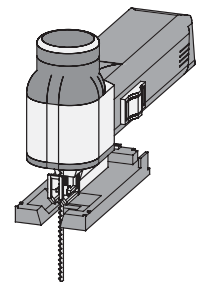
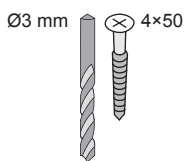

4x





 Lieber Kunde, achten Sie auf die richtige Aufbau-Variante!

 Dear customer, pay attention to the correct design variant!

 Cher client, attention à la version de montage correct!

 Geachte klant, let dan op de juiste montage-versie!

 Estimado cliente, prestar atención a la versión montaje correcto!

 Caro cliente, prestare attenzione alla versione corretto montaggio!

 Vážený zákazník, dbát na správnou montážní verzi!

 Lieber Kunde, achten Sie auf die richtige Aufbau-Variante!

A

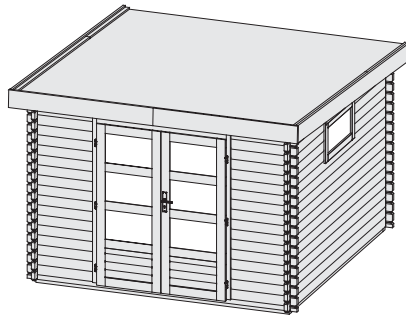

B

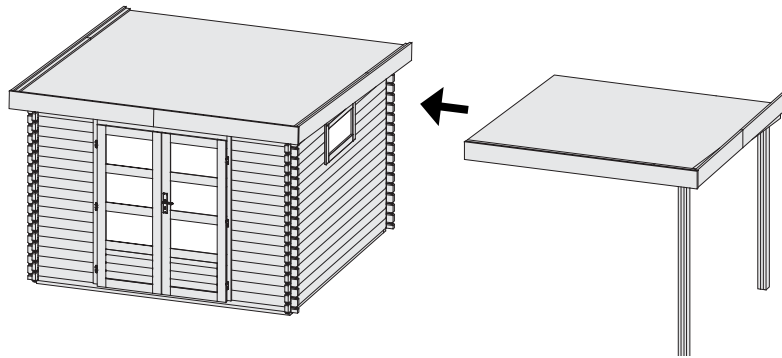

C

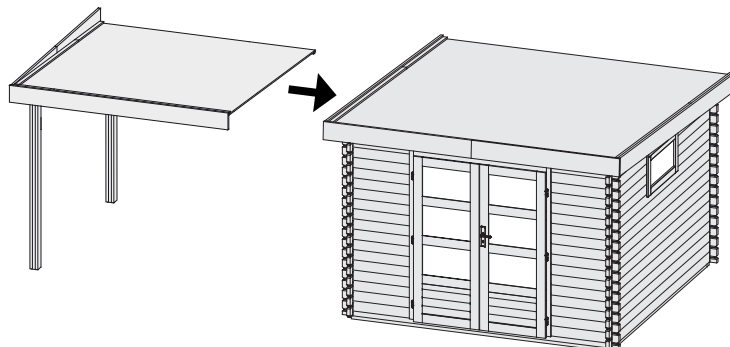

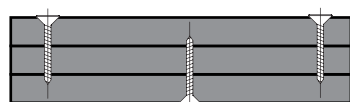
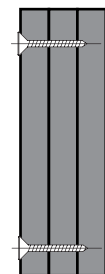
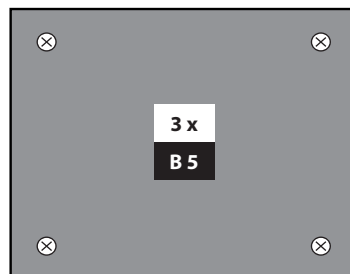

36x

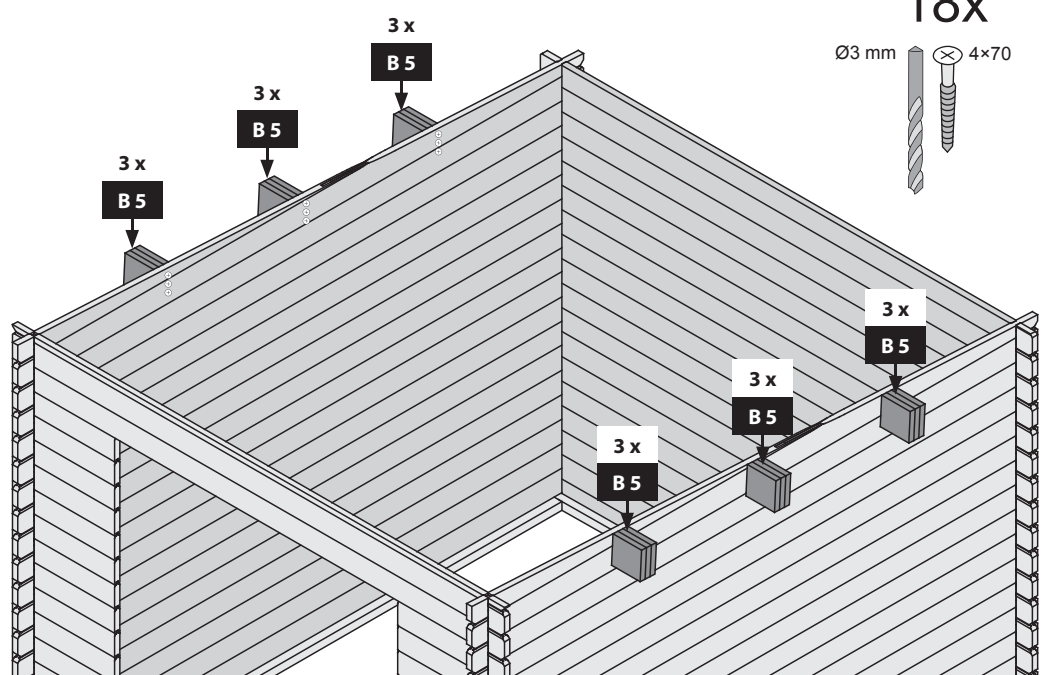
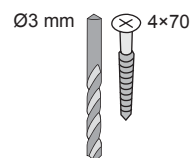

18x

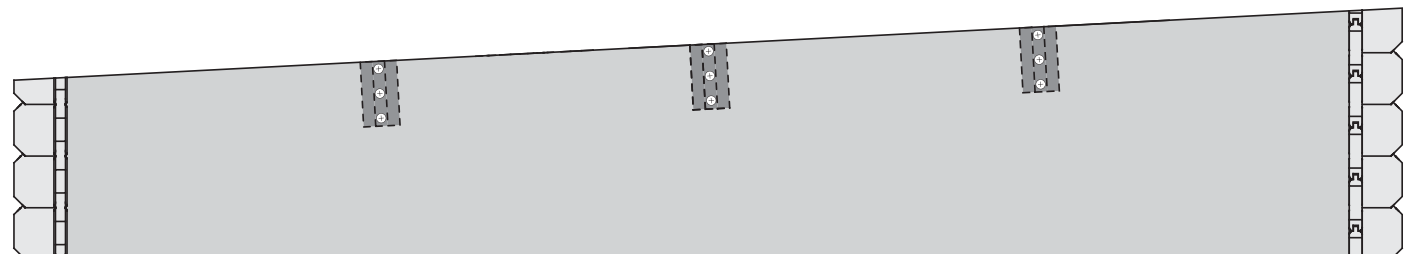
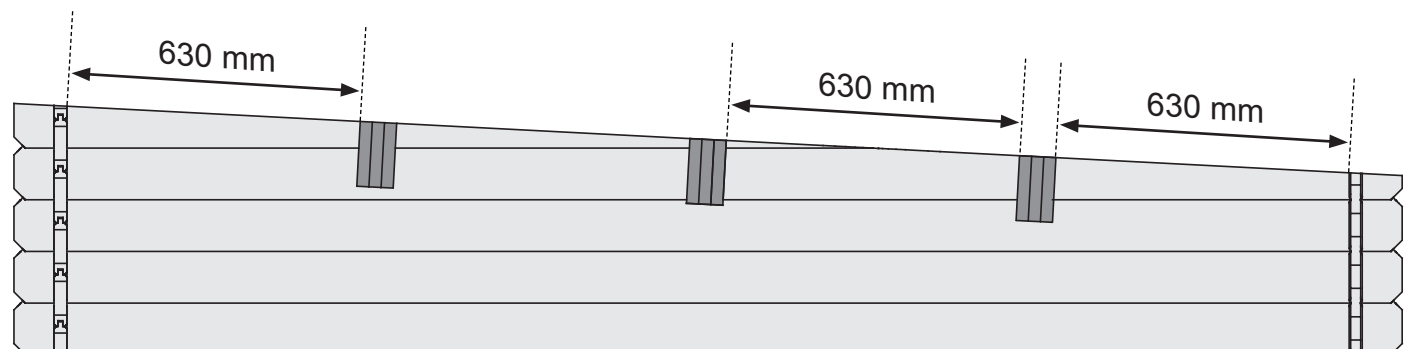
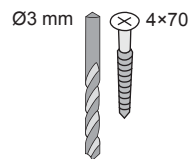

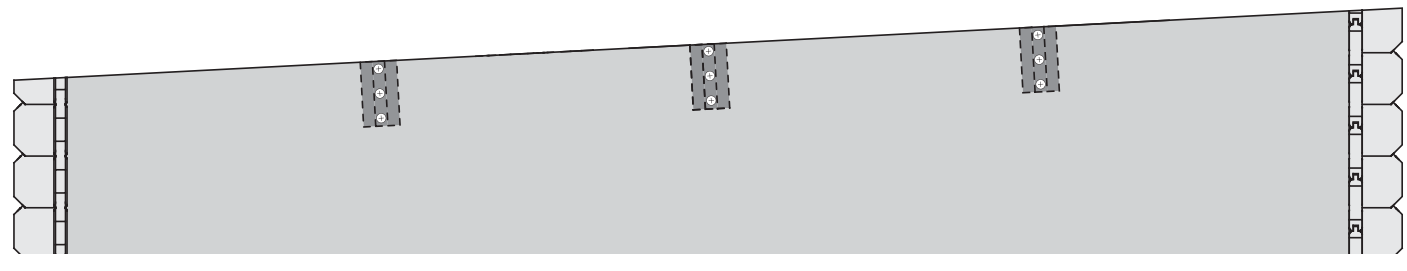
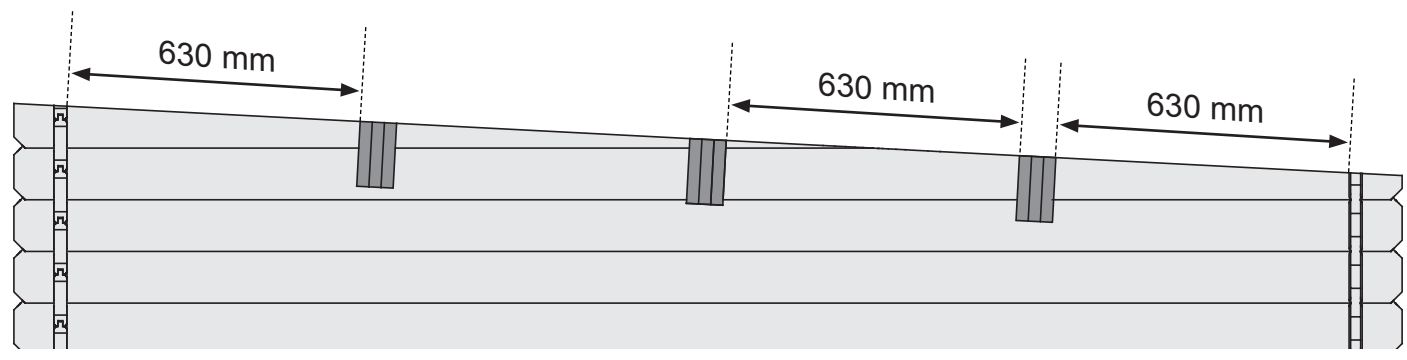
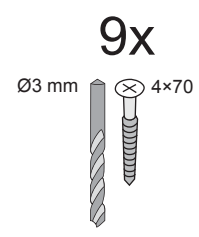
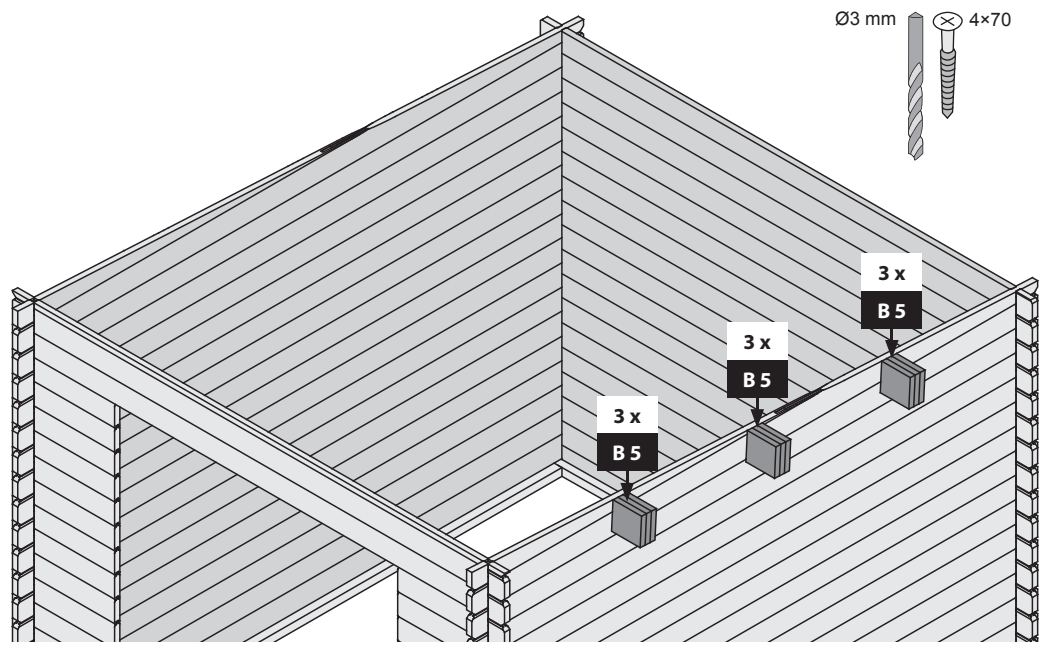
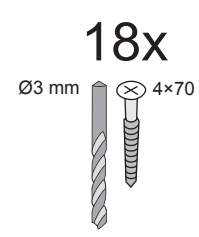
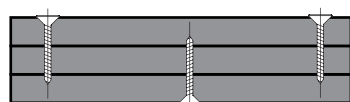
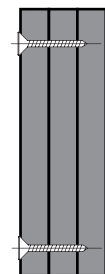
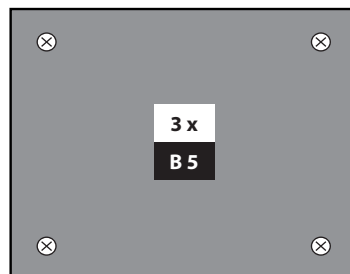

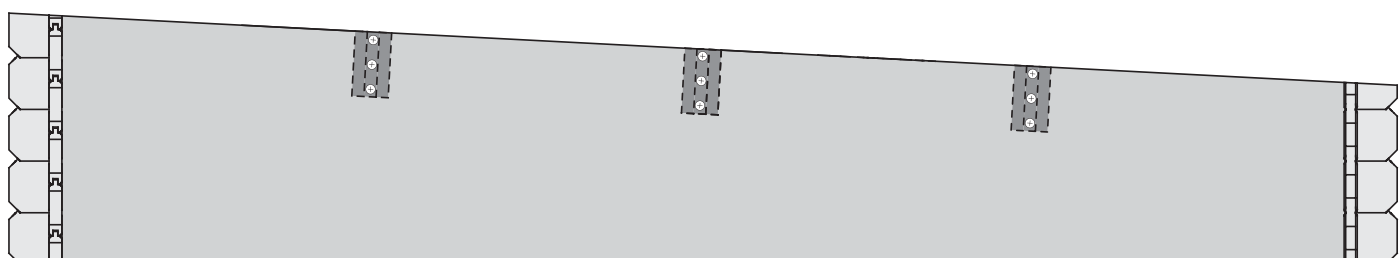
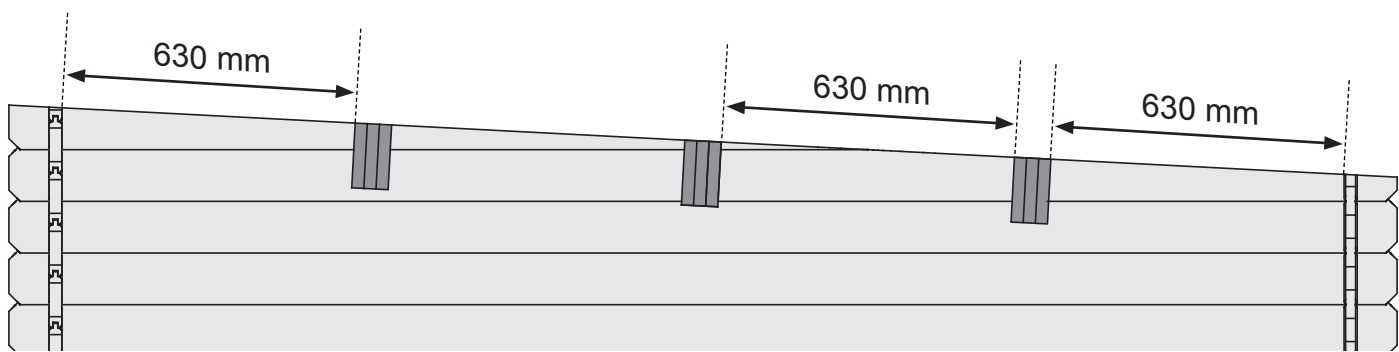
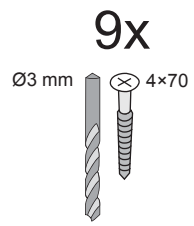
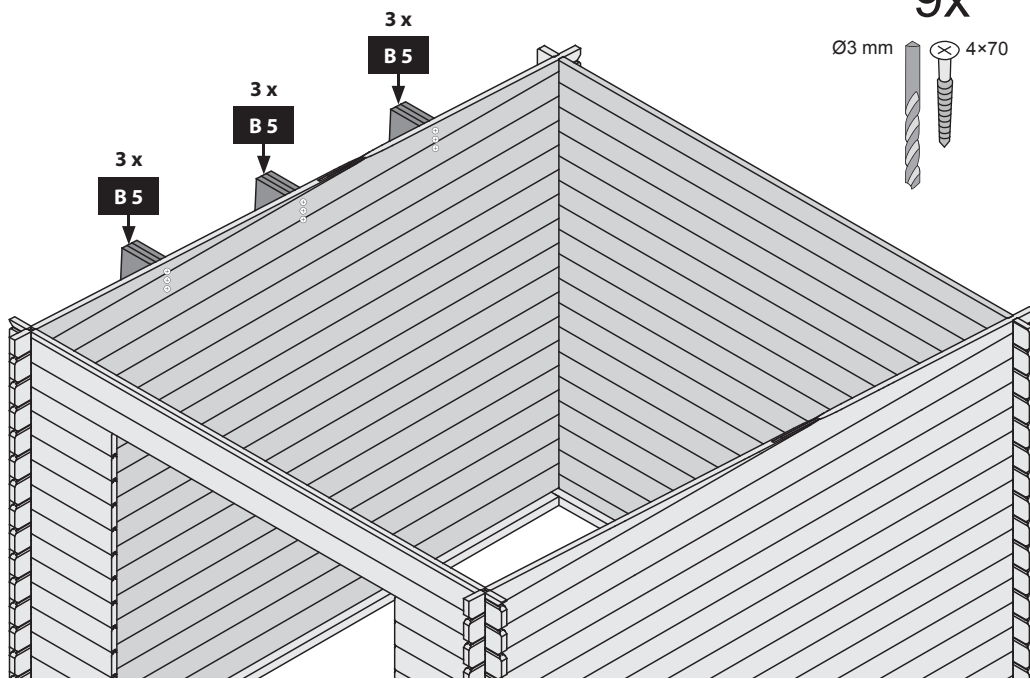
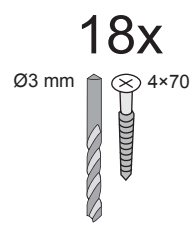
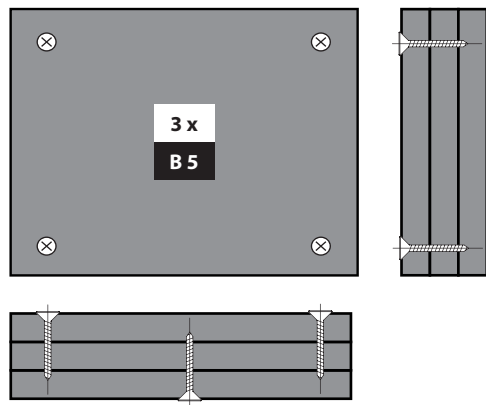

3 x
B 6

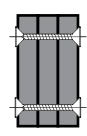
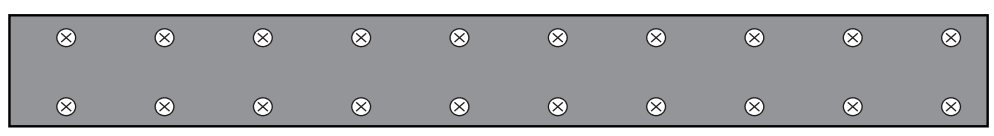

120x
Ø3 mm 4x70

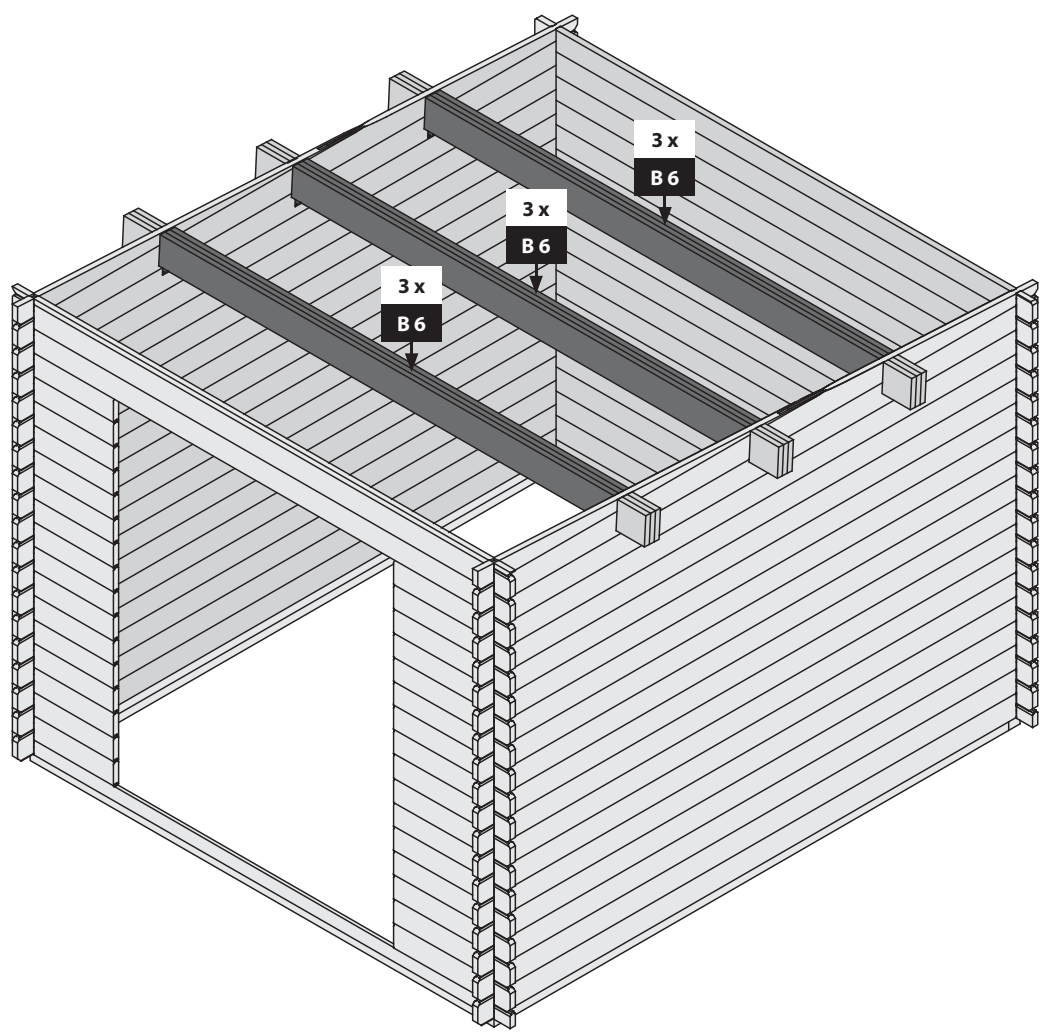
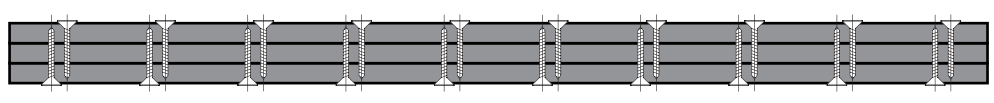

48x
Ø3 mm 4x35

-  Bündig!
-  Flush!
-  Affleurement!
-  Gelijk!
-  I flugt!
-  Aras!
-  Combacia!
-  Stejný !

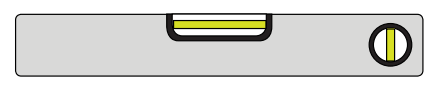
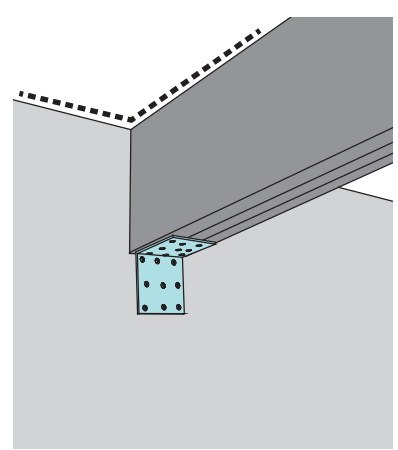

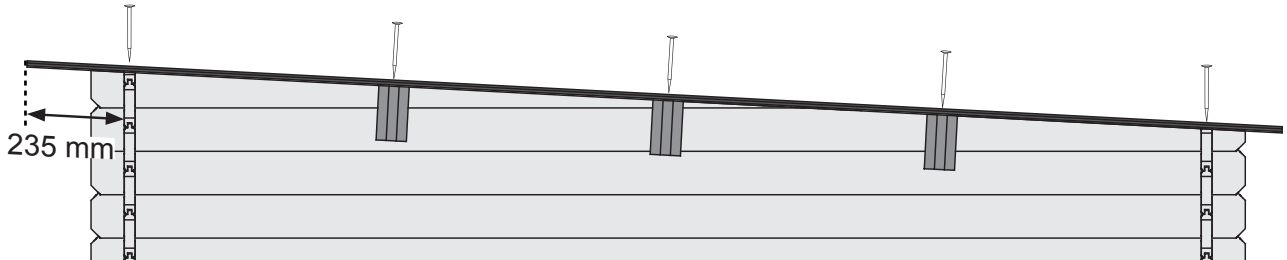
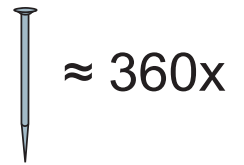
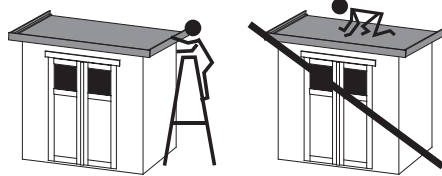
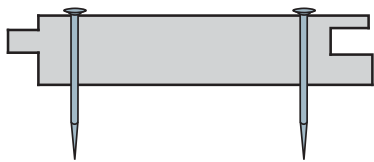

-  Bündig!
-  Flush!
-  Affleurement!
-  Gelijk!
-  I flugt!
-  Aras!
-  Combacia!
-  Stejný !

-  Bündig!
-  Flush!
-  Affleurement!
-  Gelijk!
-  I flugt!
-  Aras!
-  Combacia!
-  Stejný !

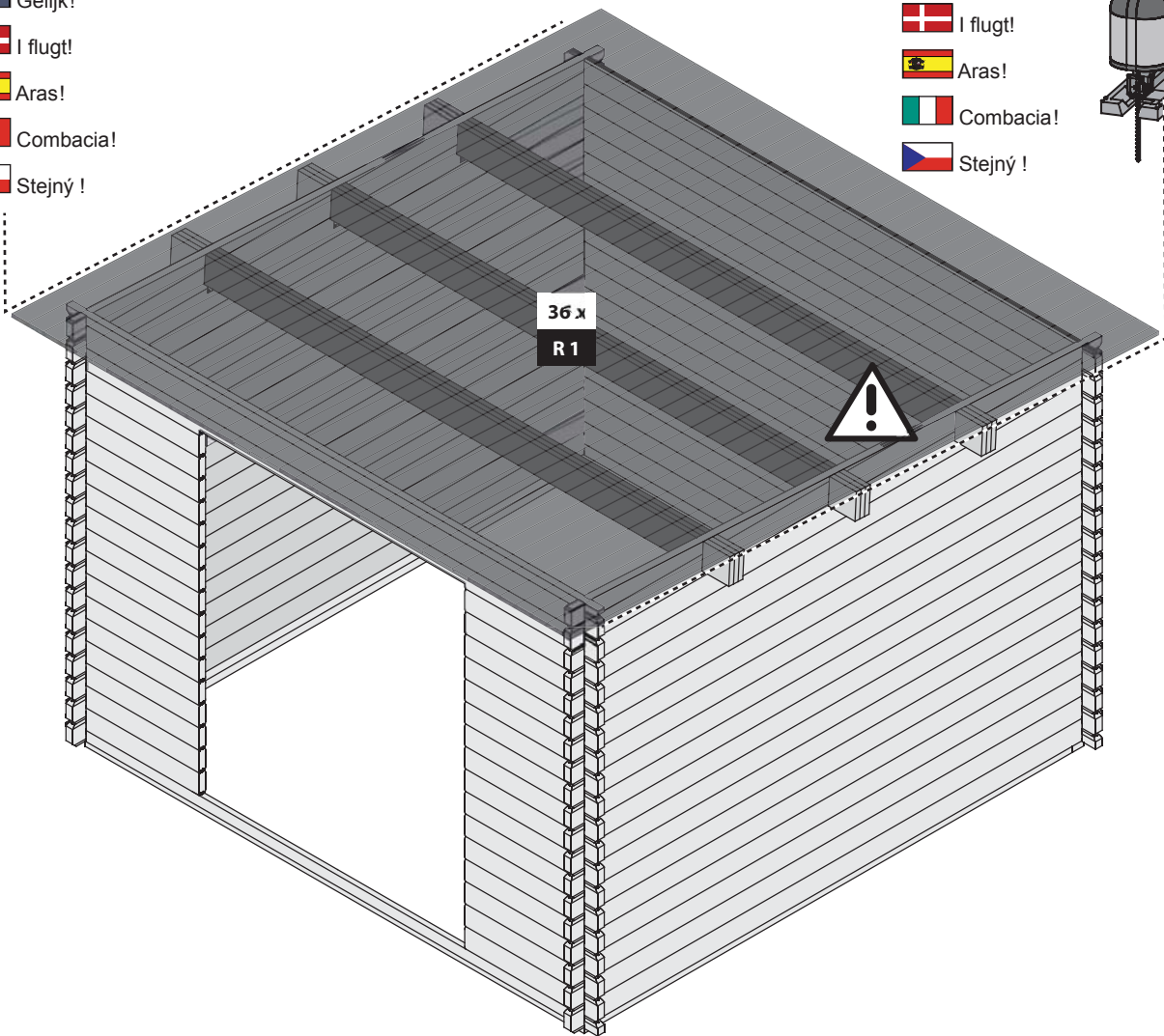
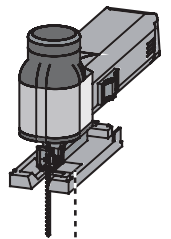

- | | |
|--|--|
|  Rückseite |  bagtil |
|  back |  trasero |
|  arrière |  posteriore |
|  achterkant |  zadní |

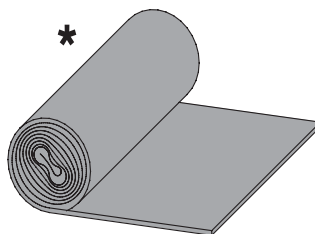
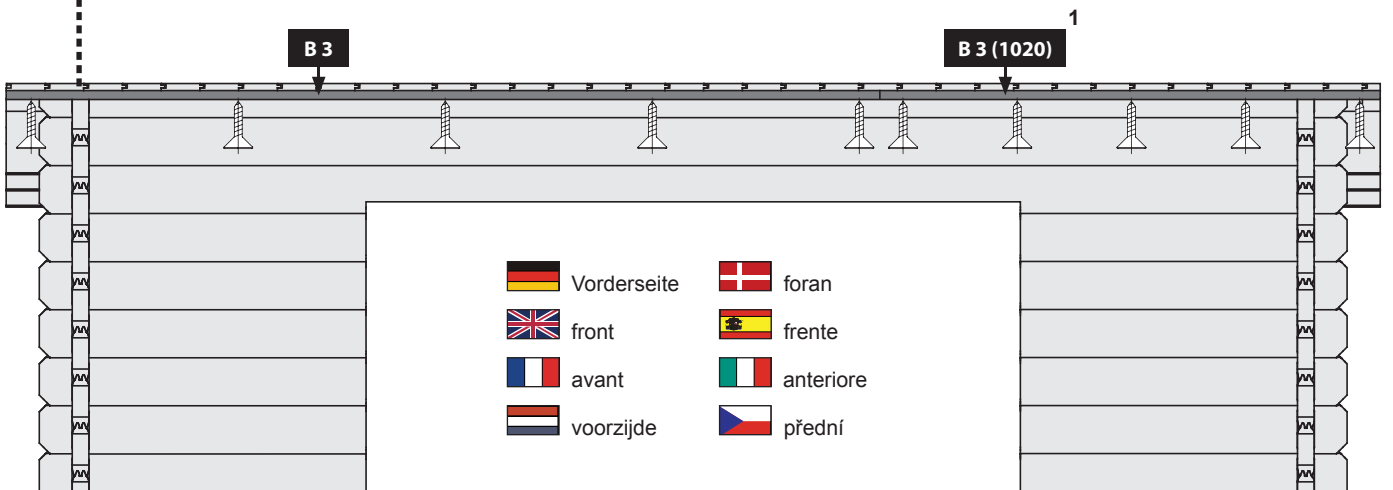
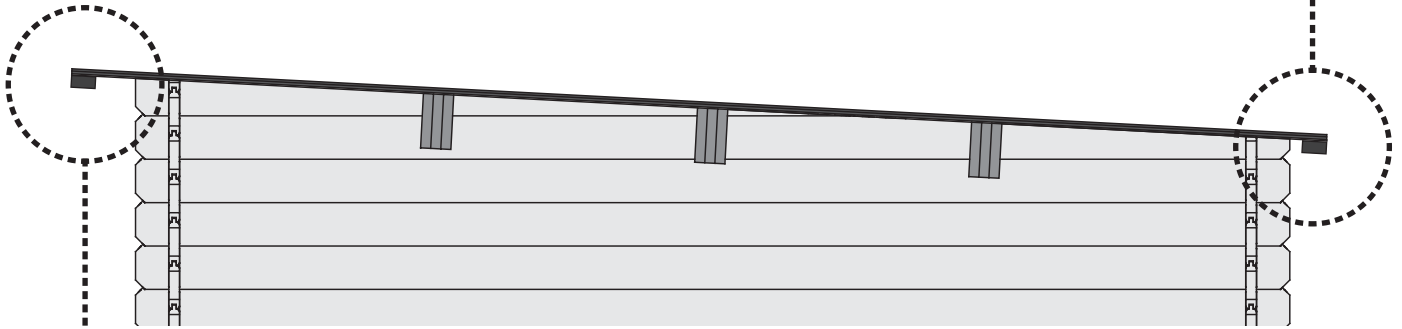
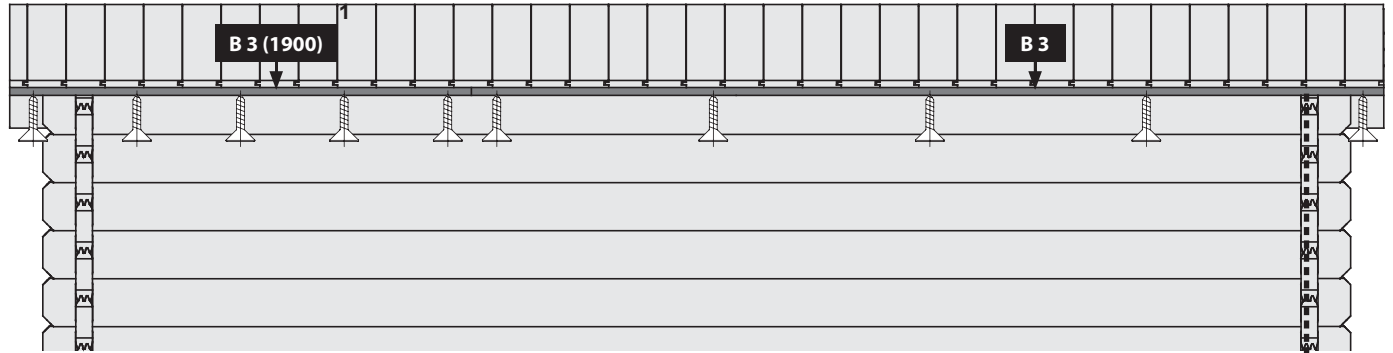
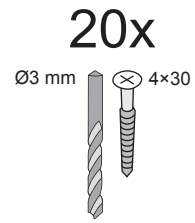

 Montage Bitumendachbelag

 Montage de toiture en bitume

 Montage bitumen underpap

 Copertura bituminosa

 Roofing felt installation

 Montage dakvilt

 Montaje de tela asfáltica

 montáž střešní krytiny

Achtung, dies ist nur ein Verlegebeispiel!

Der Bitumendachbelag dient zur Ersteindeckung und sollte nach 2 Monaten durch ein eigenes Produkt ergänzt werden. Die Anzahl der Bahnen richten sich nach Ihrer Hausgröße. Verbindungen zwischen den Bahnen sind mit einer Überlappung von ca. 10 cm auszuführen. Das Dach ist nicht begehbar. Die Konstruktion ist für eine Gesamtbelastung (Schnee, Wind) und nicht für eine Punktbelastung ausgelegt. Zur Montage empfehlen wir eine bauseitige Abstützung des Daches von unten. Die Abdichtung der Dachflächen zu angrenzenden Bauteilen mit Bitumendichtmasse ist bauseits zu lösen! Sofern es sich um ein Haus mit Satteldach handelt, sollte bei der Verwendung von Dachschindeln keine Voreindeckung mit Dachpappe vorgenommen werden. Hier sollte lediglich an den beiden Traufseiten ein 20 cm breiter Streifen mit Überstand angebracht werden. Bei Häusern mit einem Tonnendach, verlegen Sie bitte einen Bitumenbelag unter die Schindeln. Bei einem Flachdach ist die Verlegung von Dachschindeln nicht möglich!

Note! This description is only an example!

The bitumen roofing is used for initial cover and should be supplemented by a separate product according to customers choice after two months. The number of bitumen strips to be used depends on your actual house size. When joining rolls of roofing felt end to end, the overlap must be approximately 10cm. The roof is not safe to walk on. The roof is designed for a total load (snow, wind) and not for a point load. We recommend you to always support the roof from below during installation. The sealing of the roof surfaces to adjacent components with bitumen sealant has to be effected by the customer! If it is a saddle-roofed house, do not use roofing tiles for roofing. In this case, a 20 cm wide strip of bitumen with overhang should be installed on both sides of the eaves. For houses with a tonne roof, please install a bitumen roofing under the shingles. In the case of a flat roof the laying of roof shingles is not possible!

Attention, il s'agit uniquement d'un exemple de pose!

La revêtement se comprend comme dotation initiale. Il est donc recommandé de le compléter par un produit de votre choix après 2 mois. Le nombre de bandes de bitume utilisés dépend de la dimension de la maison. La jointure des bandes de bitume doit être réalisée avec un chevauchement de 10 cm. Ne pas marcher sur le toit! La construction est appropriée pour une charge totale (neige, vent) et ne pas une charge ponctuelle sur un point précis. Lors du montage, il vous est recommandé de soutenir le toit d'en dessous. L'imperméabilisation des surfaces de toit aux composants adjacents avec un mastic de bitume doit être effectuée par le client! Lorsque vous utilisez des bardeaux pour couvrir une maison avec un toit à deux versants, ne jamais utiliser toiture en bitume ci-dessous. Pour les maisons avec toit en berceau, poser du carton bitumé sous les bardeaux. Pour les maisons de toit plat de la pose de bardeaux de toiture n'est pas possible!

Let op, dit is slechts een montagevoorbeeld!

De bitumen dakbedekking wordt gebruikt voor initiële en moet worden aangevuld met een afzonderlijke product na 2 maanden. Het aantal dakviltbanen is afhankelijk van de grootte van uw huis. Verbindingen tussen de stroken uit te voeren met een overlapping van ongeveer 10 cm. Het dak is niet beloopbaar. De constructie is ontworpen voor een totaalbelasting (sneeuw, wind) en niet voor een puntbelasting. Voor de montage adviseren we te voorzien in een zelf aan te brengen steun voor het dak van onderen. De afdichting van de dakoppervlakken van aangrenzende componenten met bitumen afdichtmiddel op te lossen door de klant! Als het gaat om huis met een zadeldak, mag geen Voreindeckung worden gemaakt met dakleer in het gebruik van dakbedekking gordelroos. Hier, moet alleen de twee dakrand zijden een 20cm brede strook dakleer aan te leggen met een overstek. Voor huizen met een dak vat installeer dan een dakleer onder de gordelroos. Met een plat dak leggen shingles is niet mogelijk!

Bemærk, dette er kun et monteringsseksempel!

Den inddækning tjener kun til midlertidig inddækning og skal senest efter 2 måneder erstattes med et hertil egnet produkt. Antallet af påkrævede ruller af tagbeklædning afhænger af husets faktiske størrelse. Ved sammenføjning af tagdækning ruller ende til ende, skal overlappningen være 10 cm. Når du kun bruger 4 baner af tagpap, skal du altid dække den vandrette kantbjælke med rullerne fra begge sider. Taget er ikke sikkert at gå på. Taget er designet til en total belastning (sne, vind) og ikke for en punktbelastning. Vi anbefaler at du altid støtter taget nedenunder under installationen. Tætningen af tagfladerne til vindbrættet i forenderne skal løses af kunden! Når du bruger tagshingles til at inddække et hus med gavtag, skal du altid bruge underpap tagbeklædningen. Her lægges et 20 cm bredt bånd af tagbeklædning med overlæg på begge sider. Monter altid underpap tagbeklædningen under tagshingles til huse med et buet tag. Ved fladt tag kan tagshingles ikke anvendes!

Cuidado, éste es sólo un ejemplo de instalación!

La cubierta de betún se utiliza para inicial y debe complementarse con un producto separado después de 2 meses. La cantidad de tiras de tela asfáltica depende del tamaño de su caseta. Las juntas de tela en una tira se realizan solapando la tela asfáltica 10 cm. El techo no es transitable. La construcción está preparada para cargas totales (nieve, viento) y no para cargas puntuales. Para el montaje se recomienda apuntalar el techo por debajo. A menos que haya una casa de techo a dos aguas, sin Voreindeckung debe hacerse con tela asfáltica en el uso de tejas para techos. En este caso, sólo los dos aleros partes deben ser de una amplia franja de 20 cm de tela asfáltica que deben colocarse con un voladizo. Para las casas con el techo abovedado y por favor, instale un techo sintió debajo de las tejas. Con un techo plano por el que las tejas no es posible!

Attenzione, questo è solo un esempio di posa!

La copertura bitume è utilizzato per iniziale e deve essere completato da un prodotto separato dopo 2 mesi. La quantità dei rulli di cartone catramato dipende dalle dimensioni della casa. Il concatenamento tra i nastri deve essere effettuata con una sovrapposizione di circa 10 cm. Non salire sul tetto. La costruzione è progettata per un carico diffuso (neve, vento) e non per una concentrazione puntuale del peso. Per il montaggio si consiglia un supporto del tetto con una costruzione posta sotto di esso. Se si dispone di una casa con un tetto a capanna e si desidera utilizzare tegole di copertura, deve essere posato senza fogli di bitume. Qui, un largo 20 cm striscia di bitume deve essere montato esclusivamente ad entrambi i lati della grondaia sporgente 20 cm. Per le case con fogli di bitume per tetti a botte sotto il fuoco di Sant'Antonio da installare. Si prega di non utilizzare il fuoco di Sant'Antonio Dackdeckung con un tetto piatto.

Pozor, toto je jen příklad, kterým!

Bitumen se používá pro počáteční a by měl být doplněn samostatný produkt po 2 měsících. Počet Dachpappbahnen závisí na velikosti domu. Spojení mezi asfaltem pásu má být provedena s přesahem asi 10 cm. Při použití pouze čtyři běhy ne Firstbahn použití, boční panely s ležel přes hřeben. Střecha není přístupný. Konstrukce je (sníh, vítr) a není určen pro bodové zatížení na celkové zatížení. Pro montáž doporučujeme znovu podporu na místě střechy zespodu. Utěsnění střešních oblastí do podhledů na čelních plochách je na místě řešit! Máte-li dům se sedlovou střechou, je třeba žádné Asfaltové pásy umístěny pod šindele. Zde je 20 cm široký pás střešní plst' je pouze na obou stranách okapového se supernatantem odloženou. Pro rodinné domy s valenou střechou prosím ležel lepenkový pod šindelem. Pro ploché střechy domů pokládka střešních šindelů není možné!

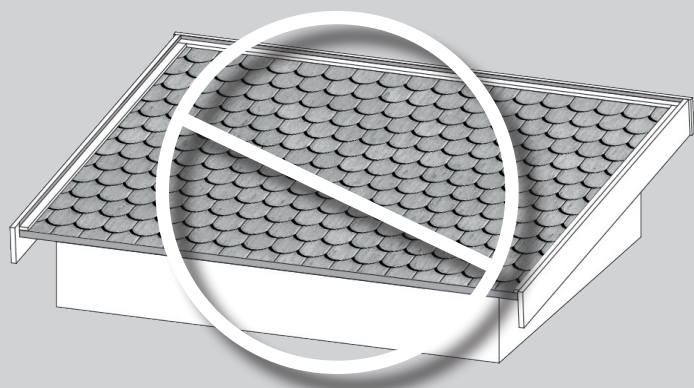
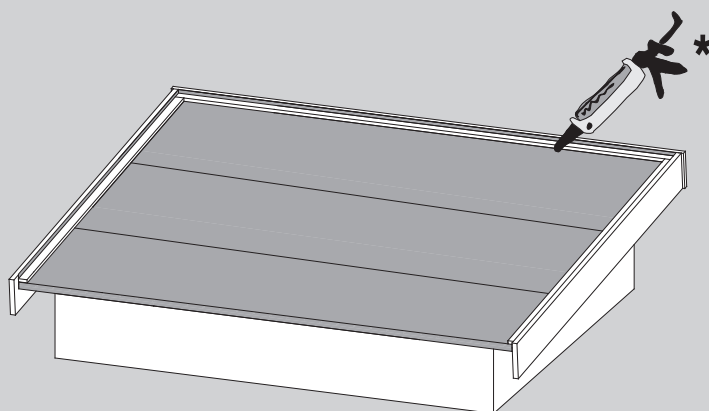
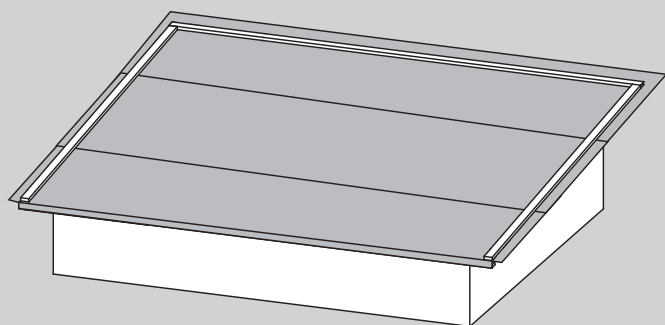
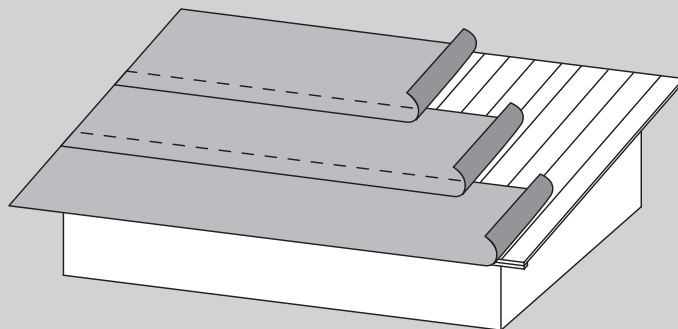
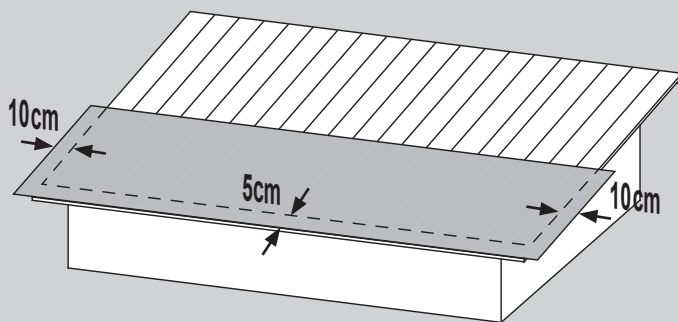
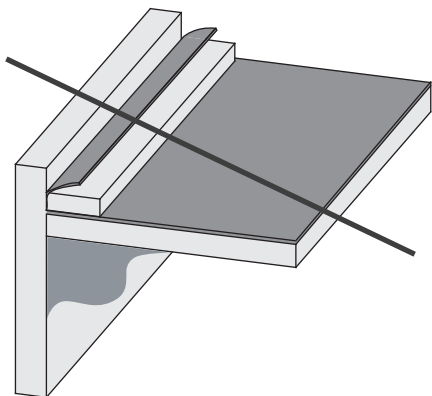
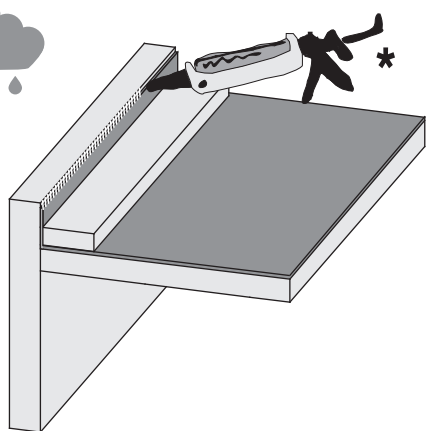
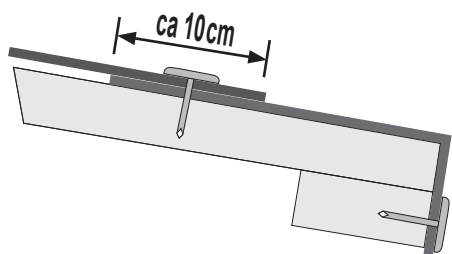
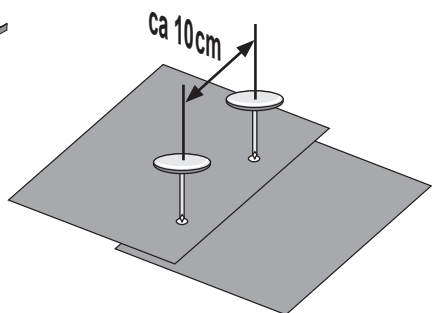
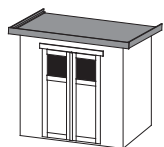



*

 Nicht im Lieferumfang enthalten! Vor Feuchtigkeit schützen!

 Not included! Protect from moisture!

 Non comprises dans la livraison! Protéger de l'humidité!

 Niet bijgeleverd! Beschermen tegen vocht!

 Ikke inkluderet! Beskyt imod fugt!

 No forman parte del suministro! Protegerlo de la humedad!

 Non incluso! Proteggere dall'umidità!

 V ceně není zahrnuto! Chránit před vlhkostí!

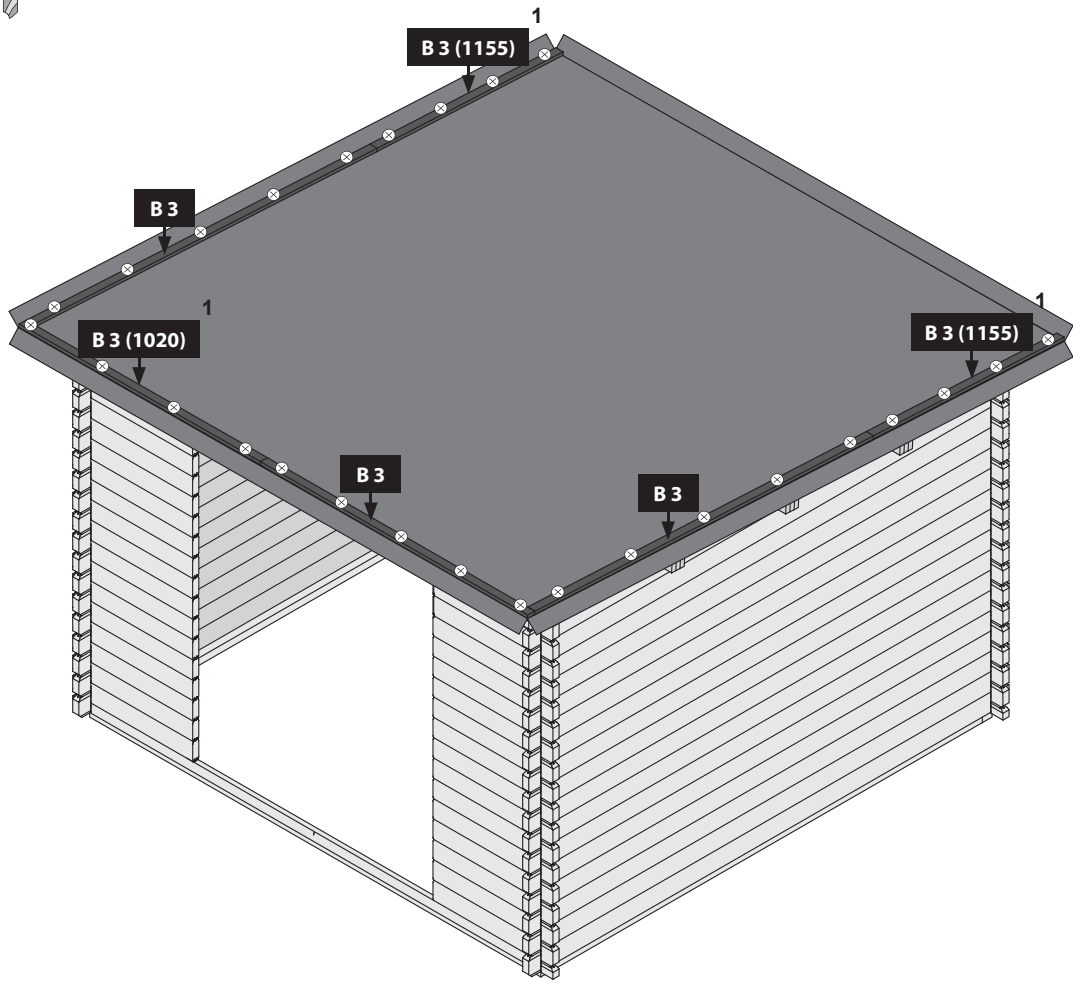
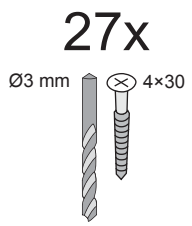
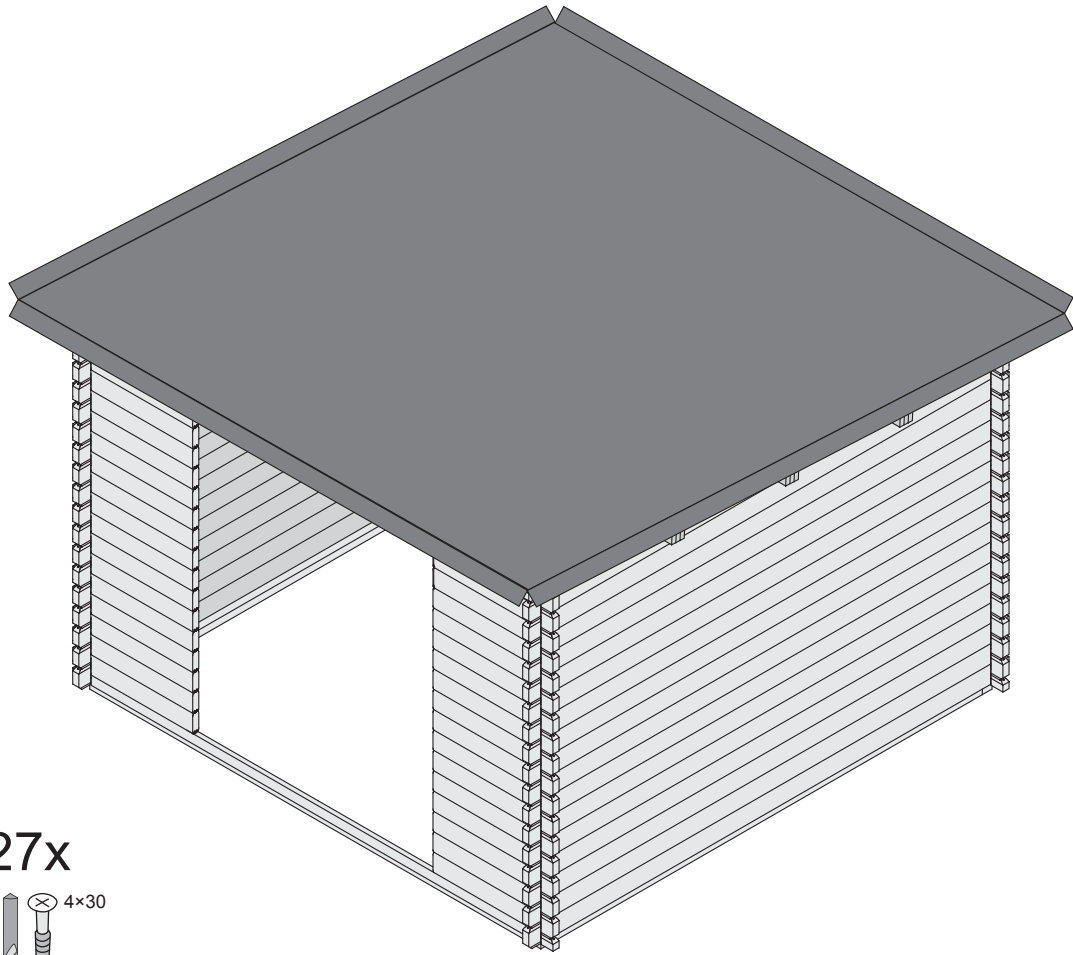

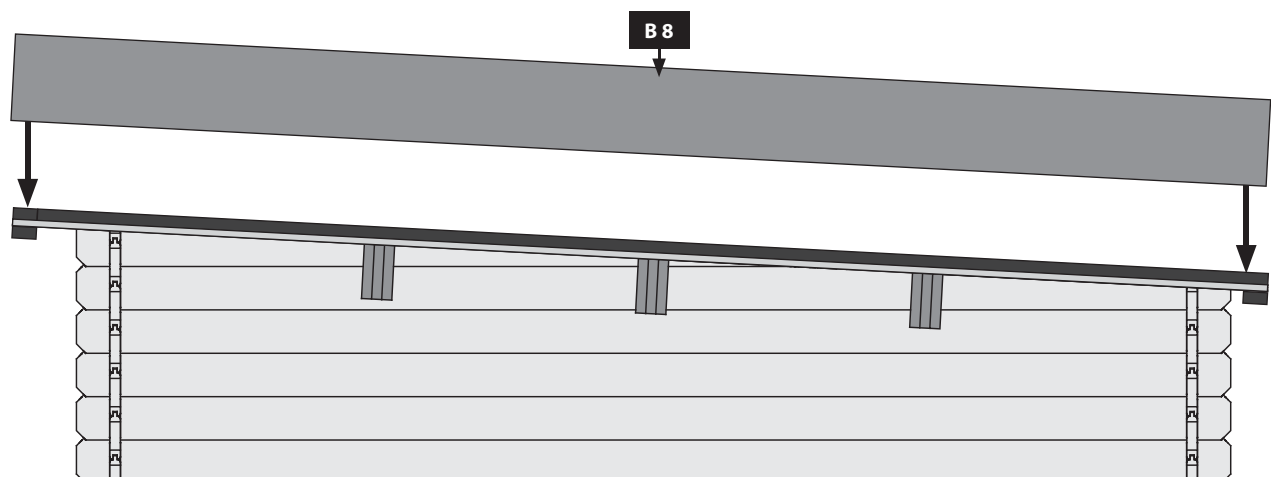

Ø3 mm 4x50
20x

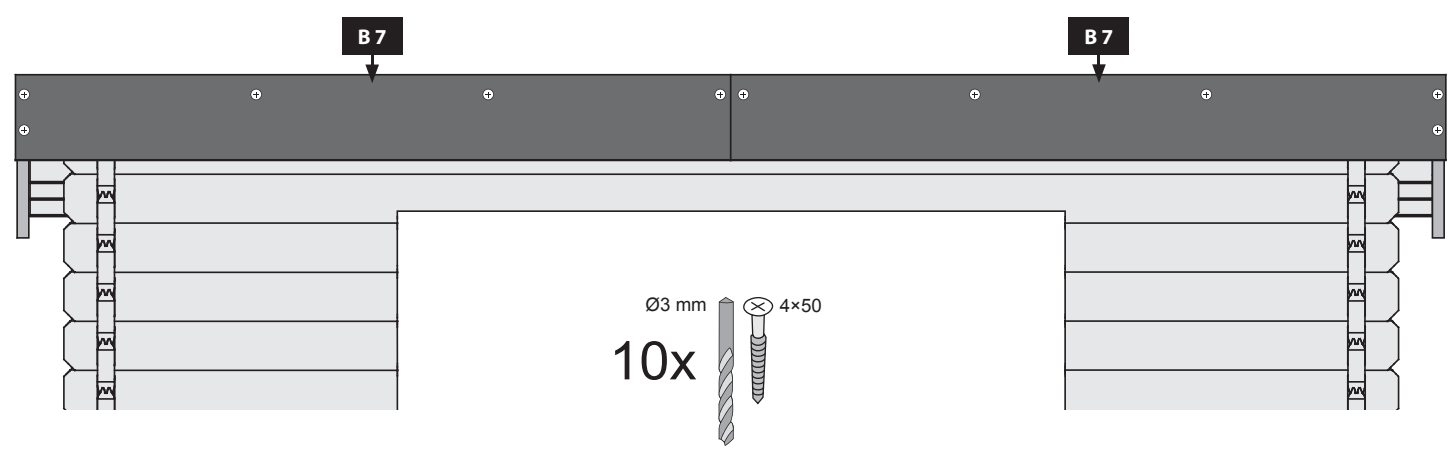
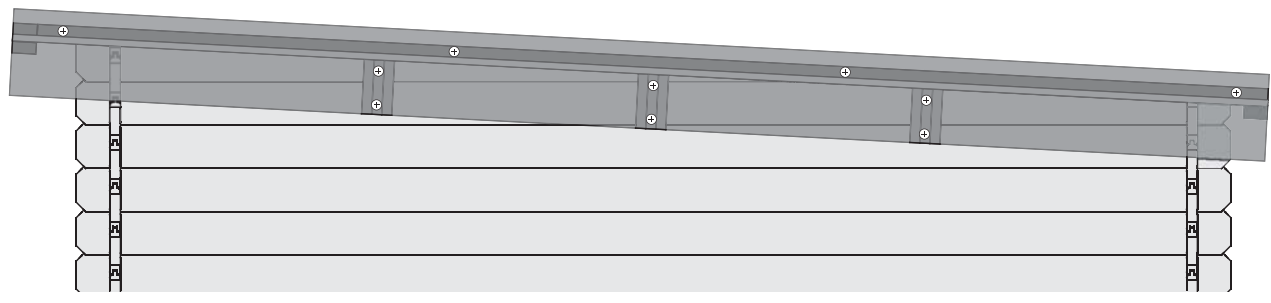

Ø3 mm 4x50
10x

	Bündig!
	Flush!
	Affleurement!
	Gelijk!
	I flugt!
	Aras!
	Combacia!
	Stejný !

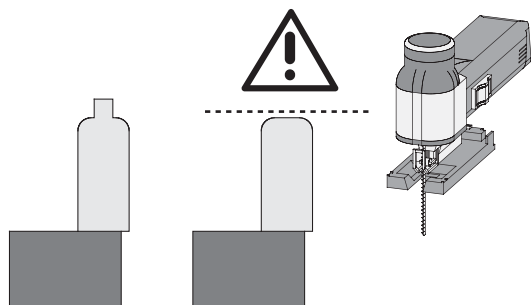
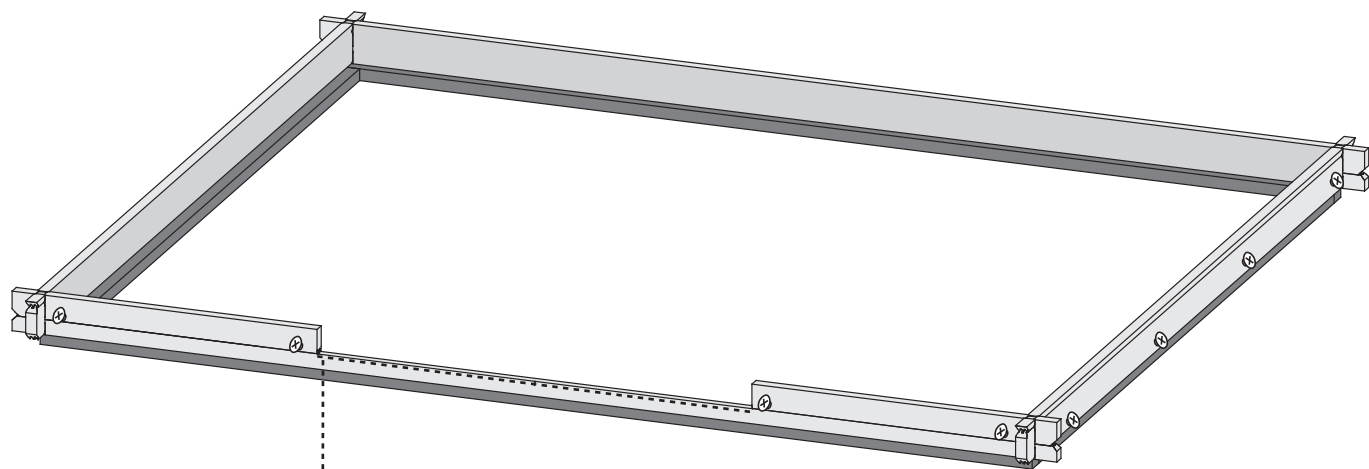
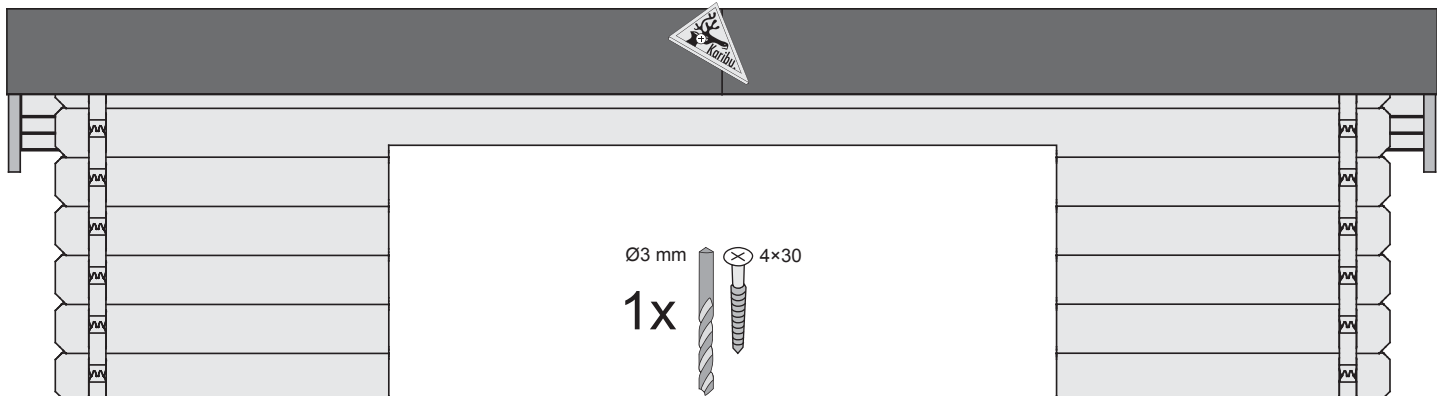

Ø3 mm 4x50
16x

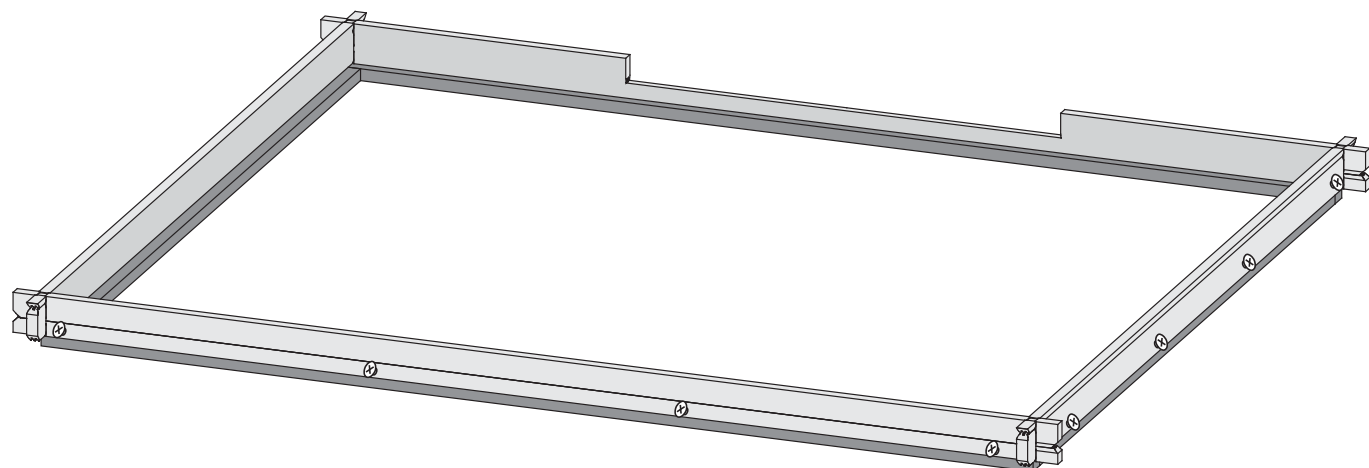
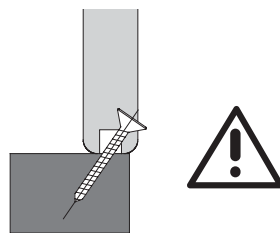

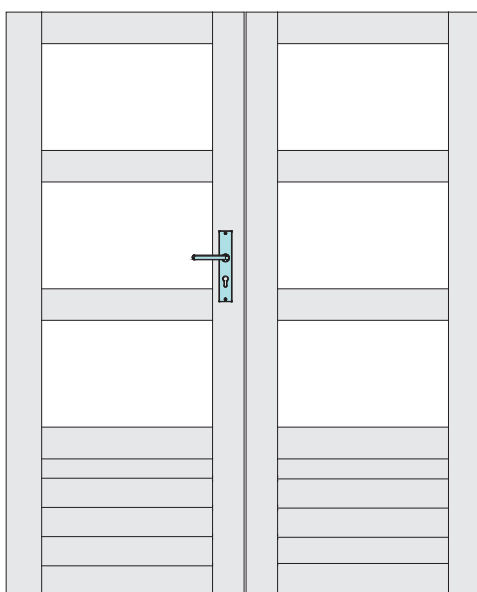

-  **Aufbauanleitung**
-  **Building Instructions**
-  **notice de montage**
-  **montagehandleiding**
-  **Montagevejledning**
-  **Instrucciones de construcción**
-  **Istruzioni per il montaggio**
-  **Montážní návod**

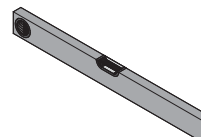
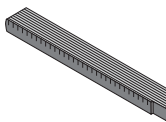
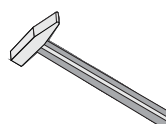
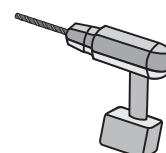
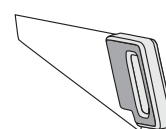

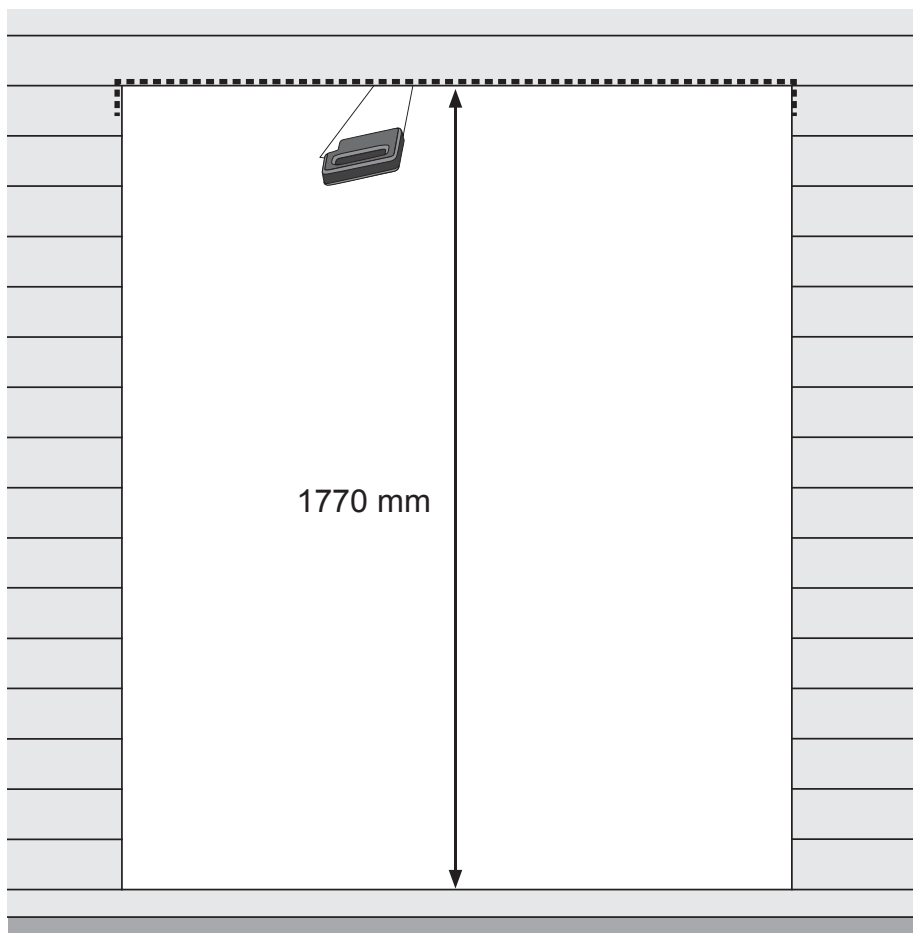

-  Bündig!
-  Flush!
-  Affleurement!
-  Gelijk!
-  I flugt!
-  Aras!
-  Combacia!
-  Stejný !

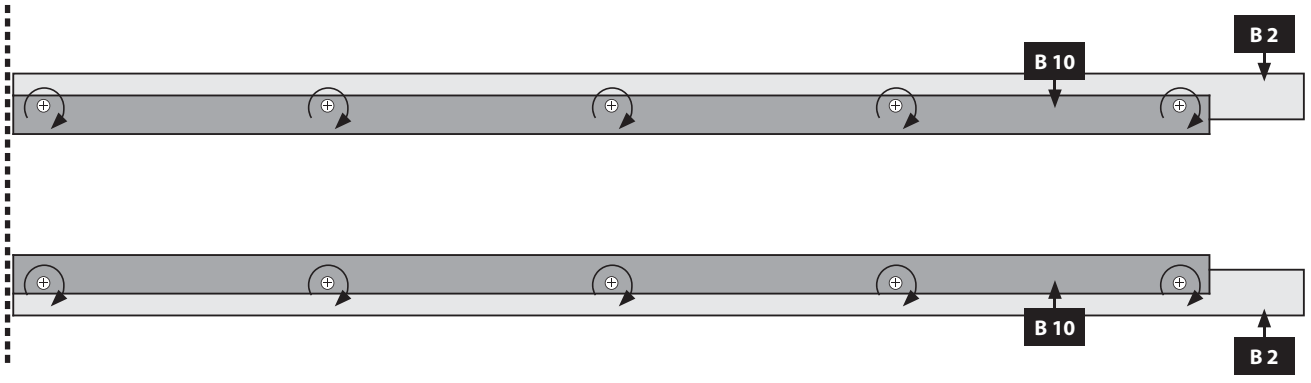
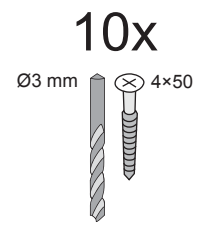
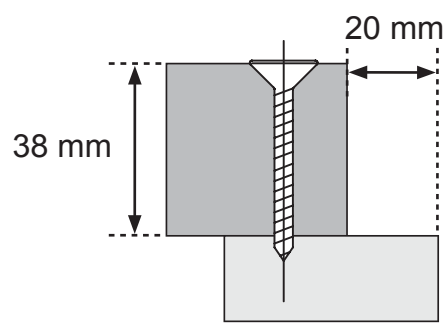

9x

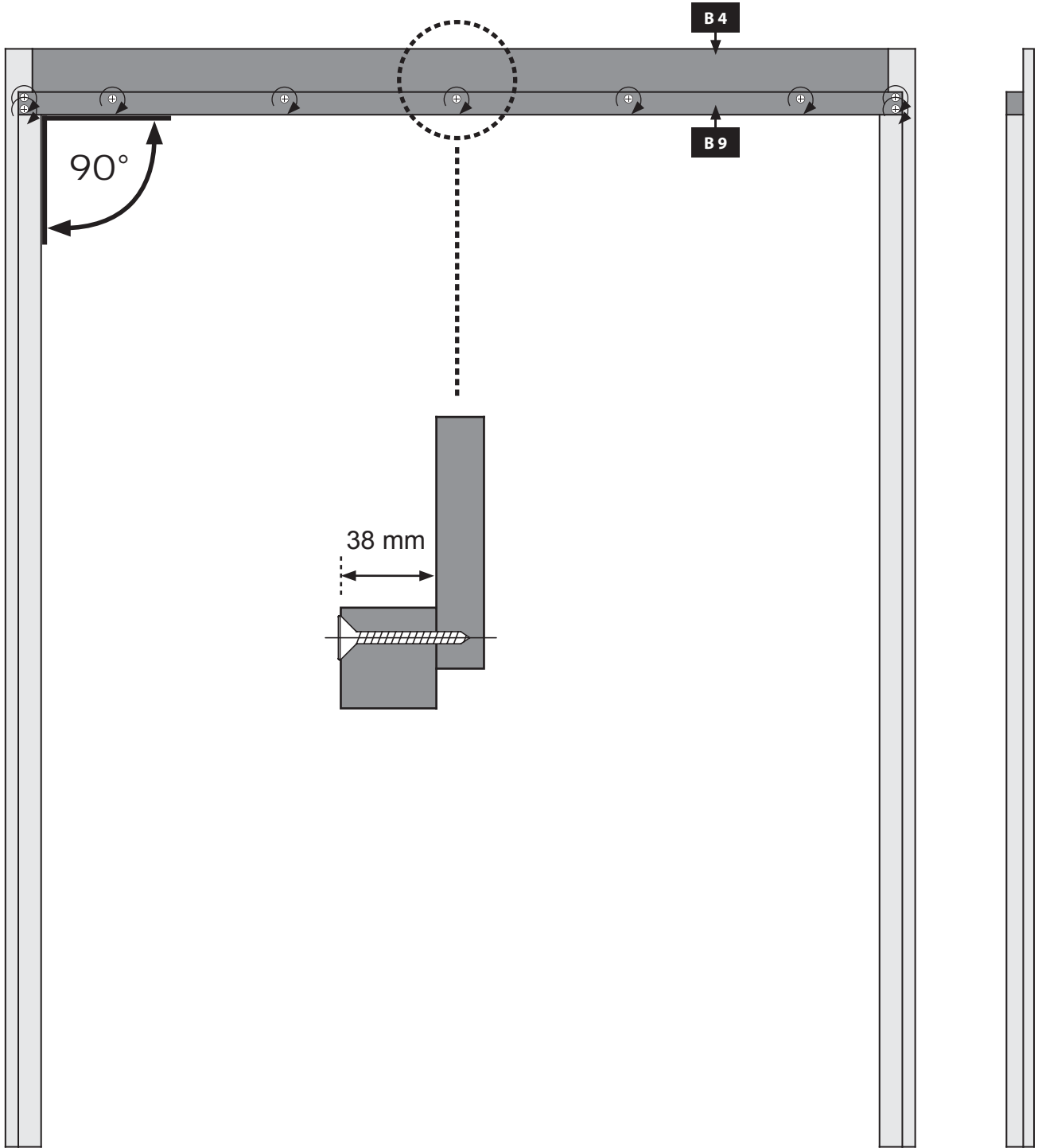
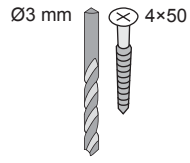

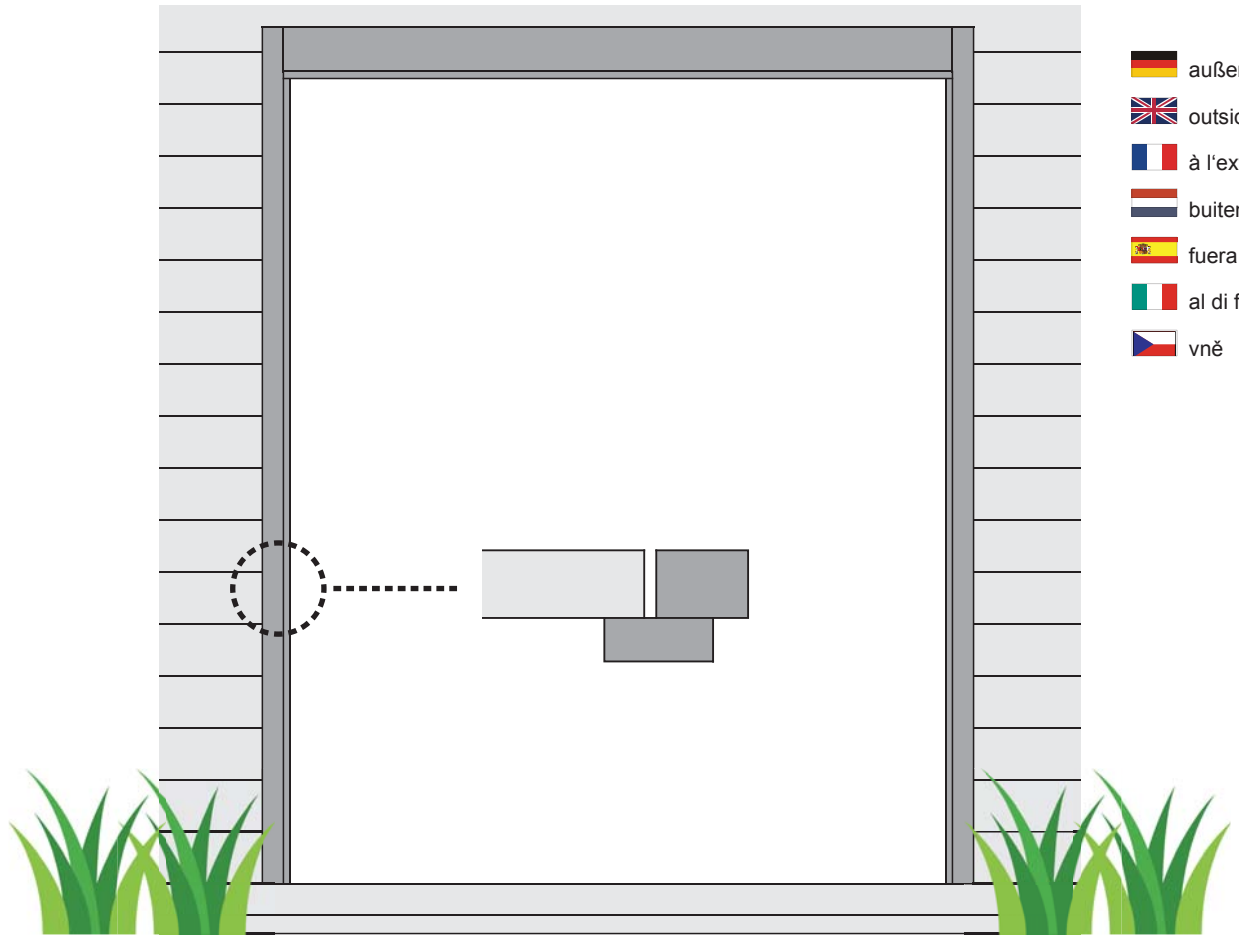

-  außen
-  outside
-  à l'extérieur
-  buiten
-  fuera
-  al di fuori
-  vně

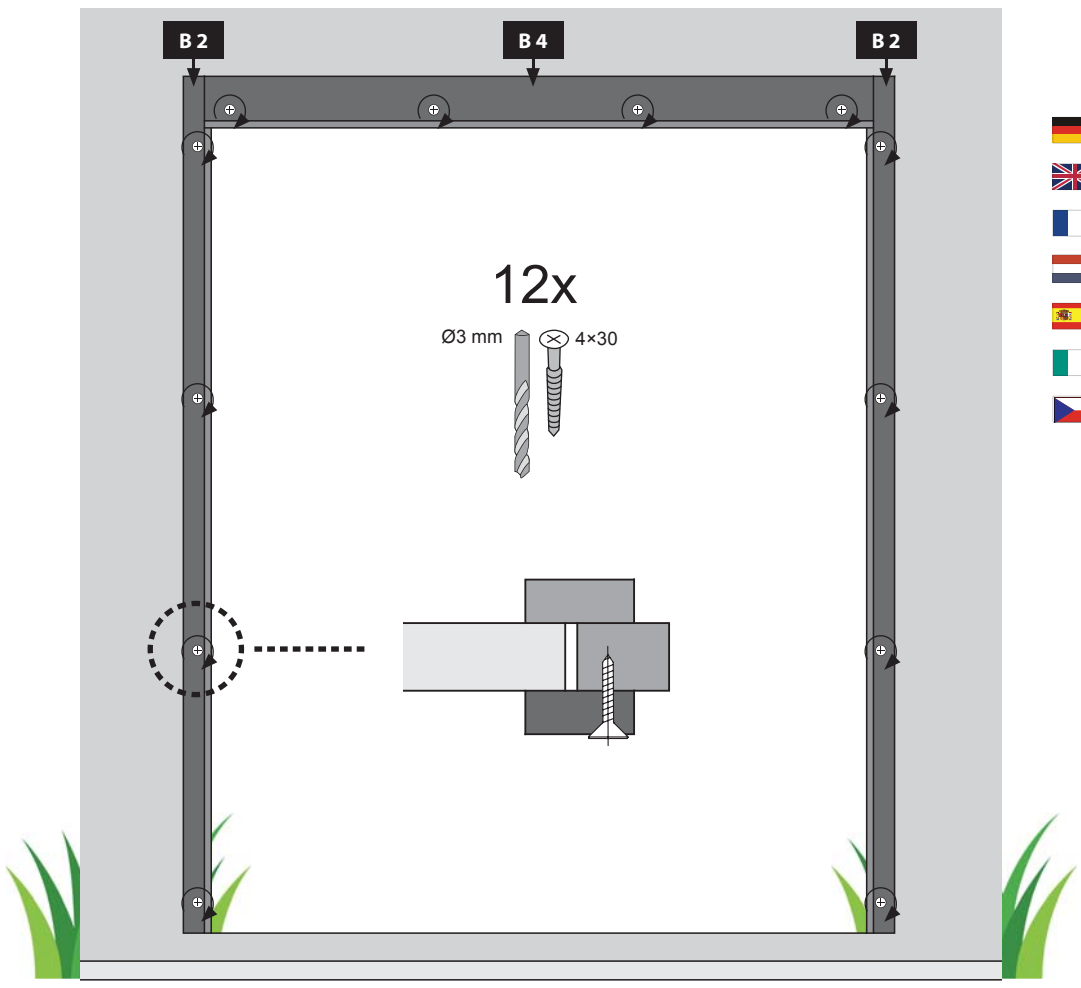

-  innen
-  Inside
-  à l'intérieur
-  binnen
-  dentro
-  dentro
-  uvnitř

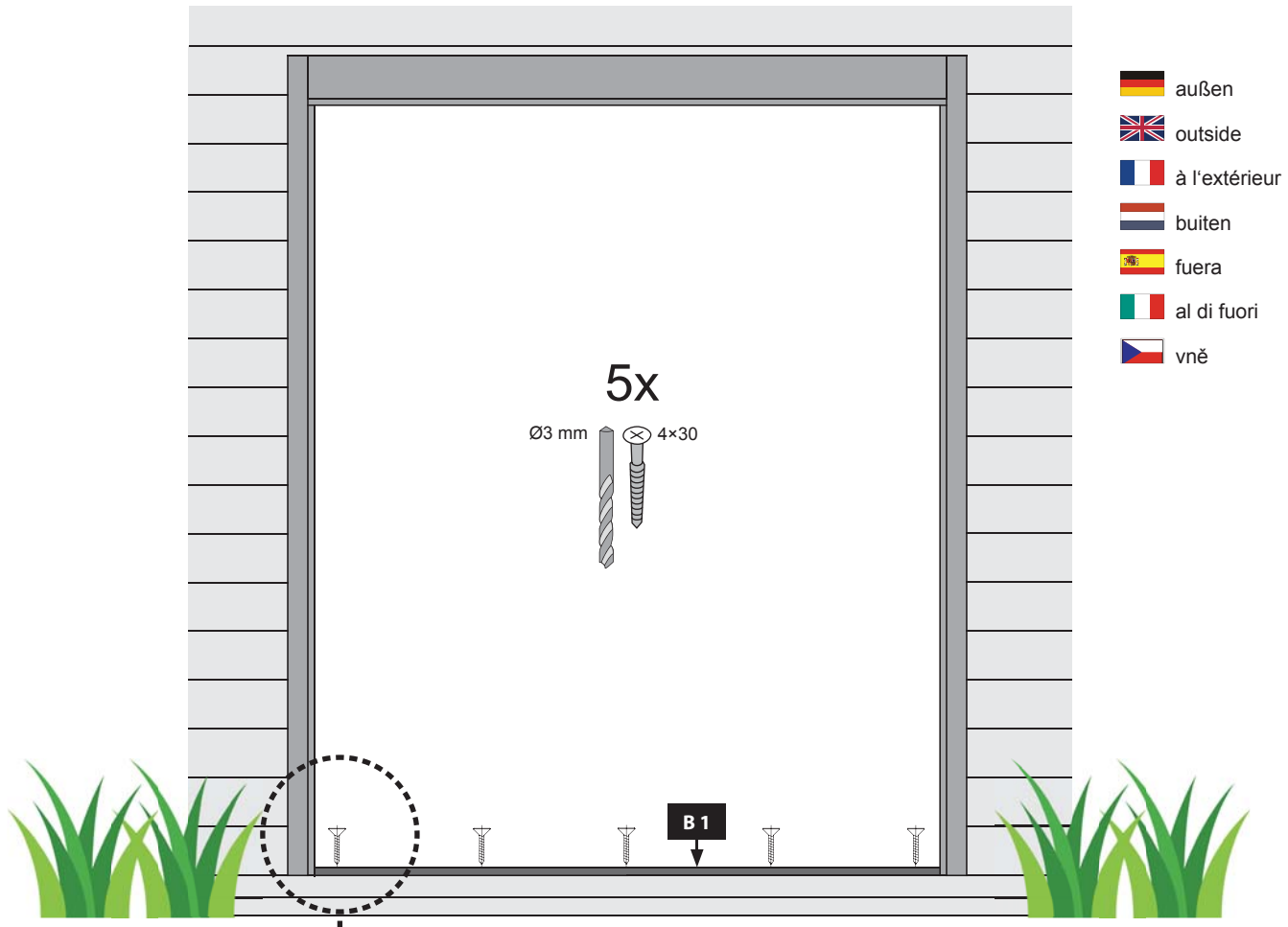

-  außen
-  outside
-  à l'extérieur
-  buiten
-  fuera
-  al di fuori
-  vně

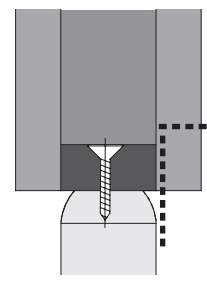
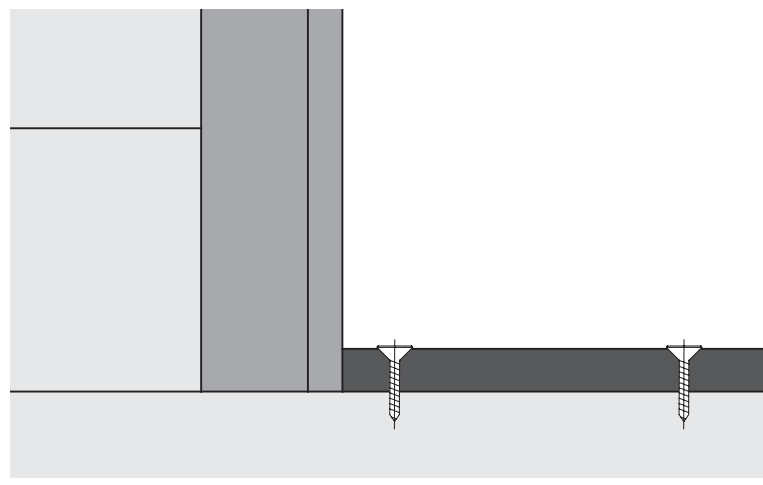

-  Bündig!
-  Flush!
-  Affleurement!
-  Gelijk!
-  I flugt!
-  Aras!
-  Combacia!
-  Stejný !



 Schutzfolie abziehen

 Remove protective film

 Retirer le film protecteur

 Verwijder de beschermende film

 Fjern beskyttelsesfilm

 Retire la película protectora

 Rimuovere la pellicola protettiva

 Odstraňte ochranný film

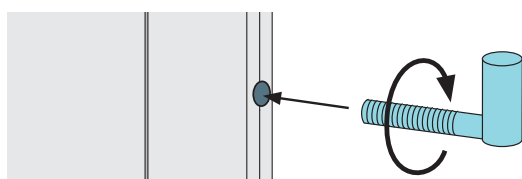
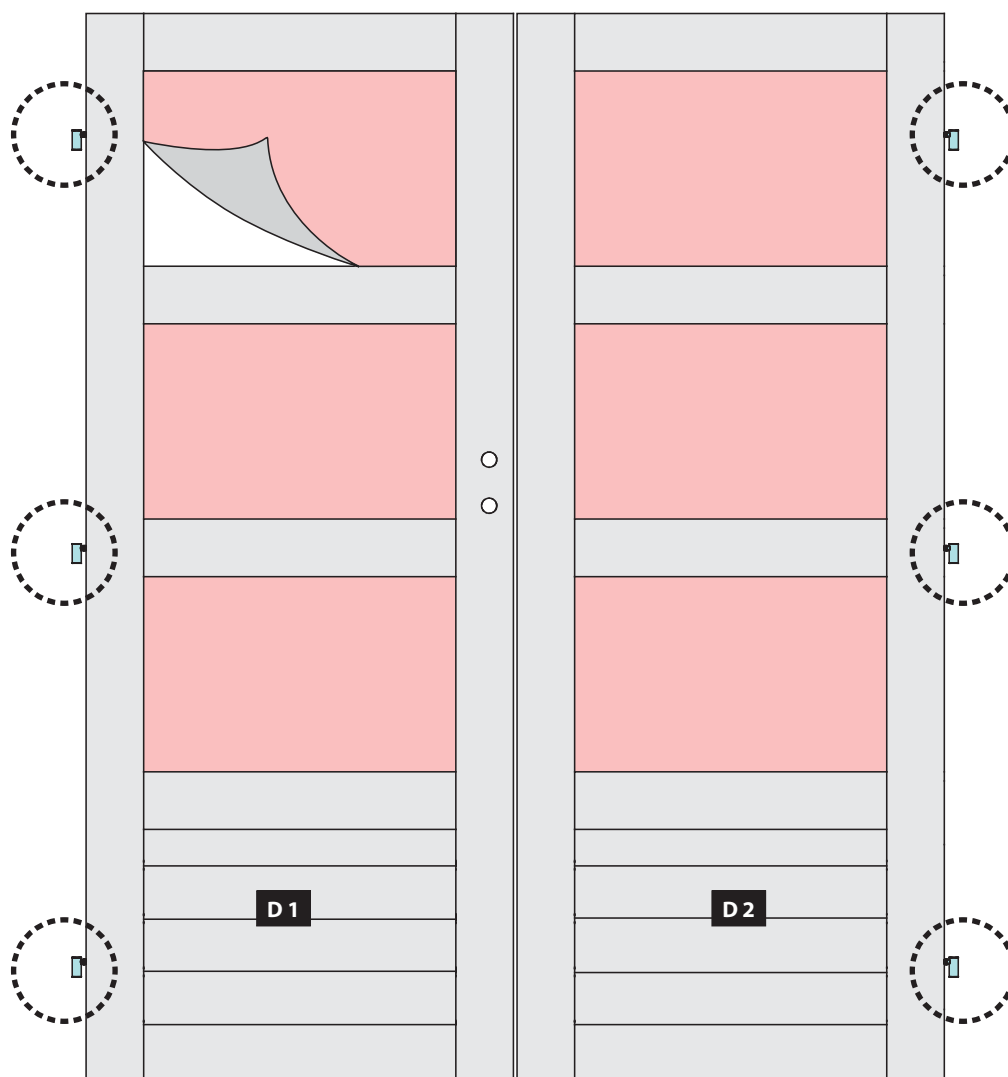

18x

Ø3 mm 4×30

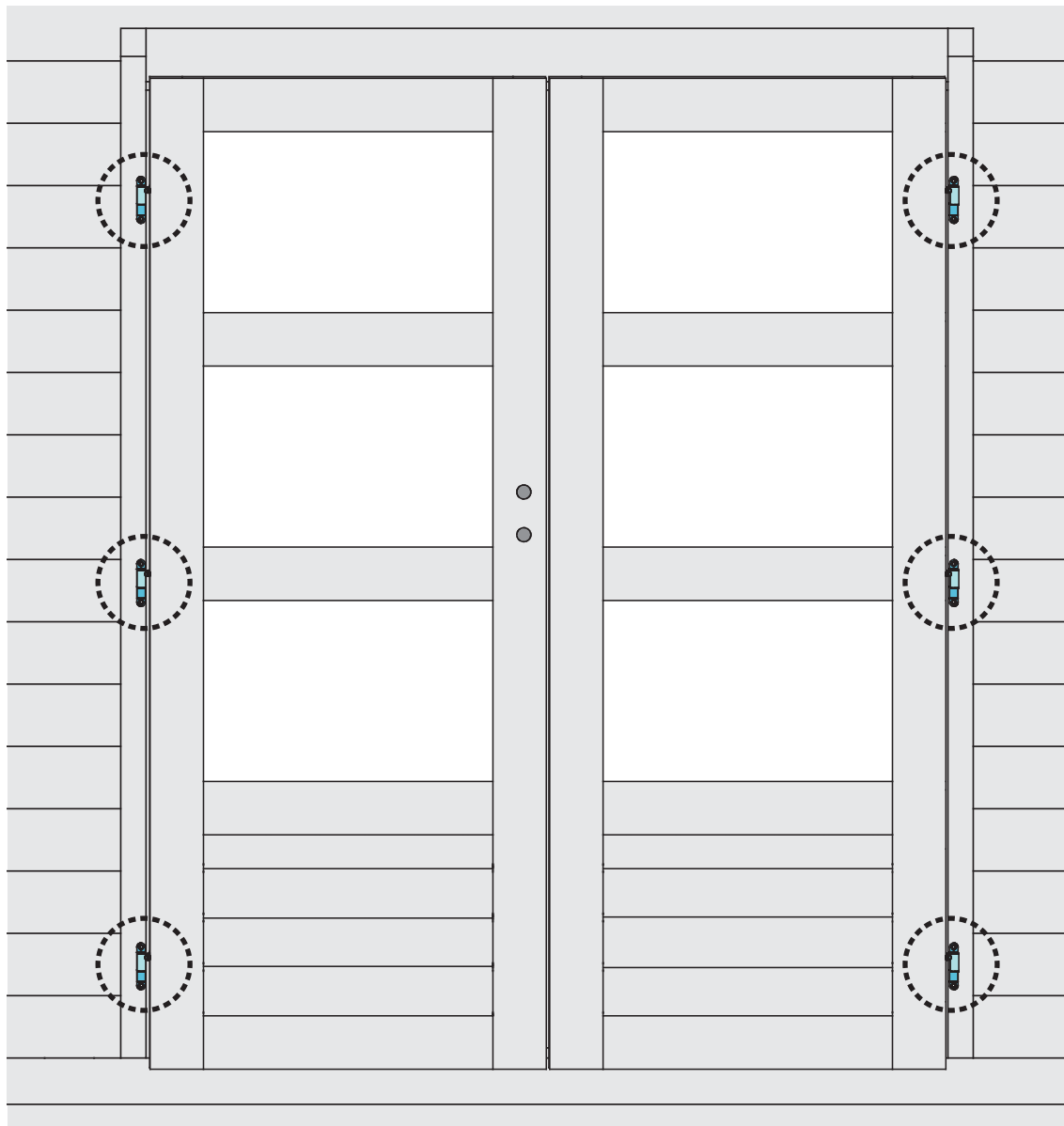
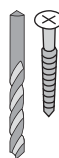

1.

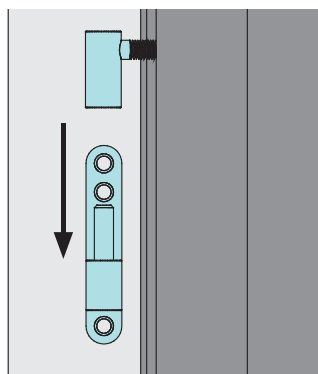

2.

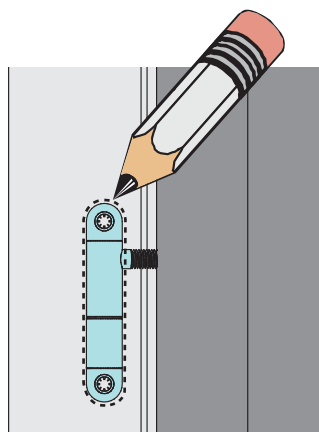

3.

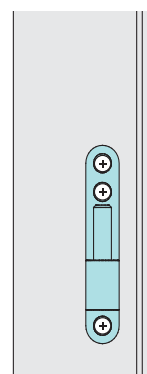

5x

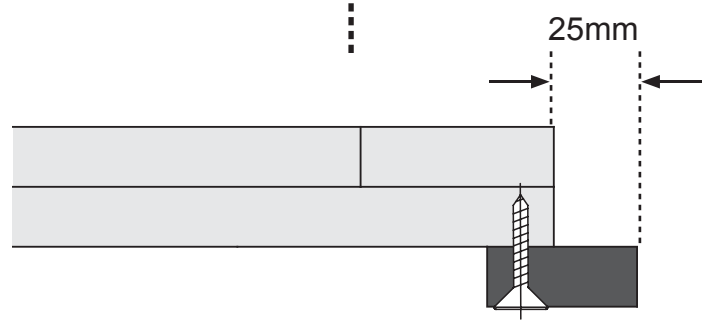
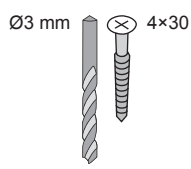

8x

Ø3 mm 4x18

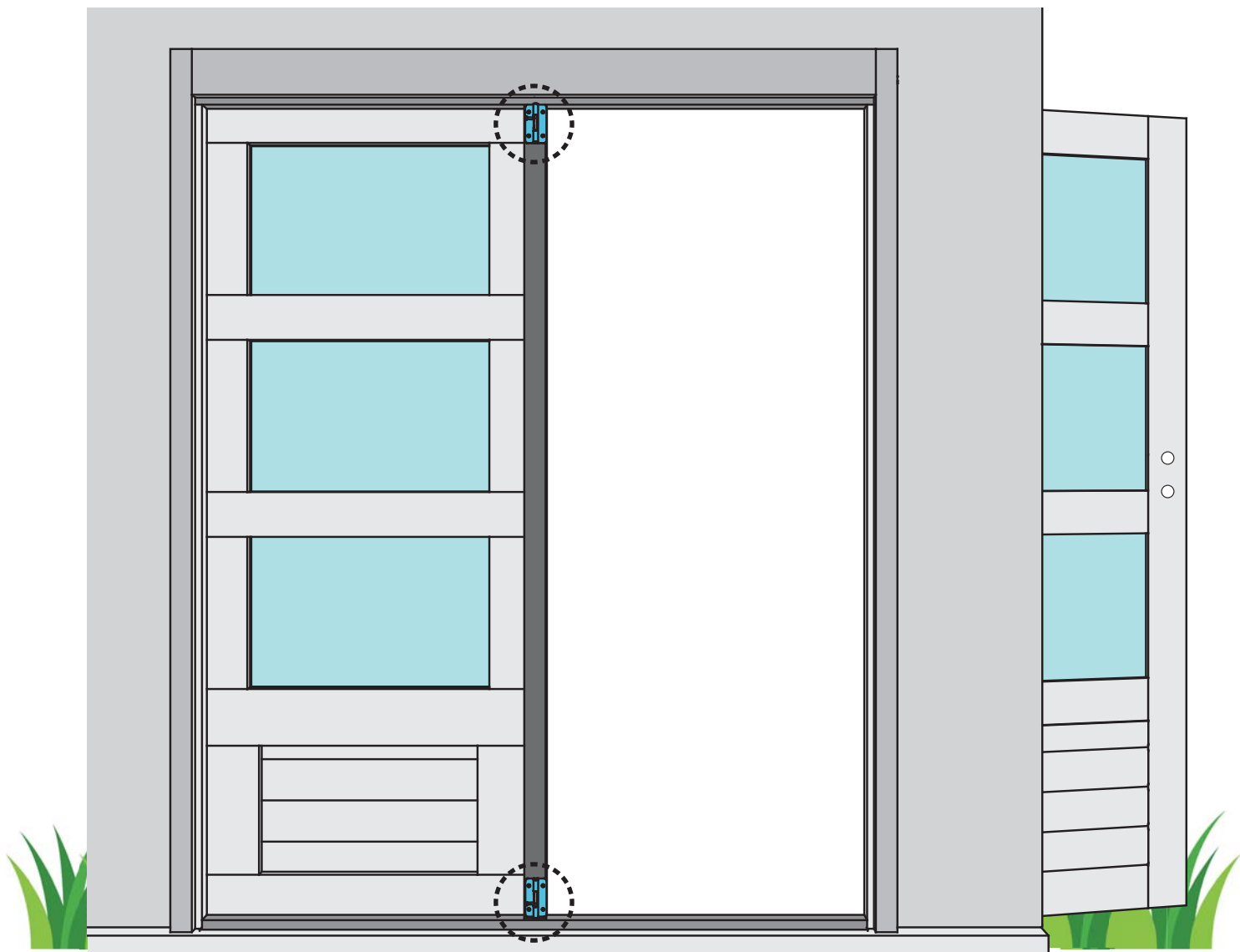
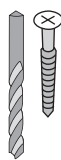

1.

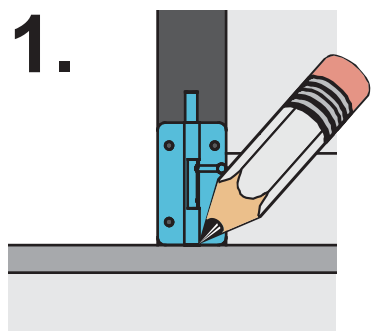

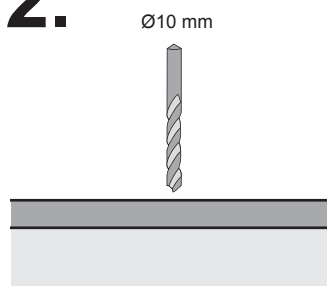

2.

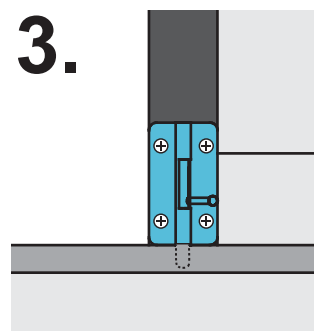

3.

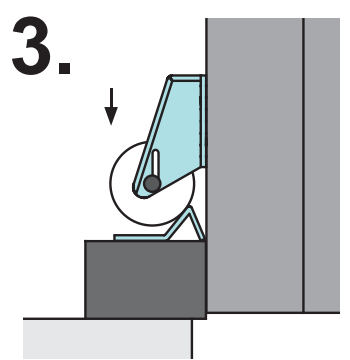
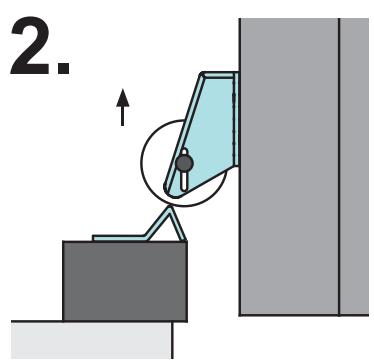
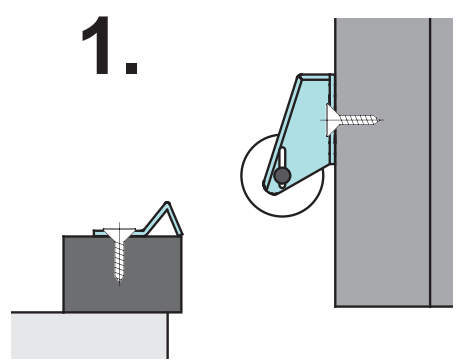
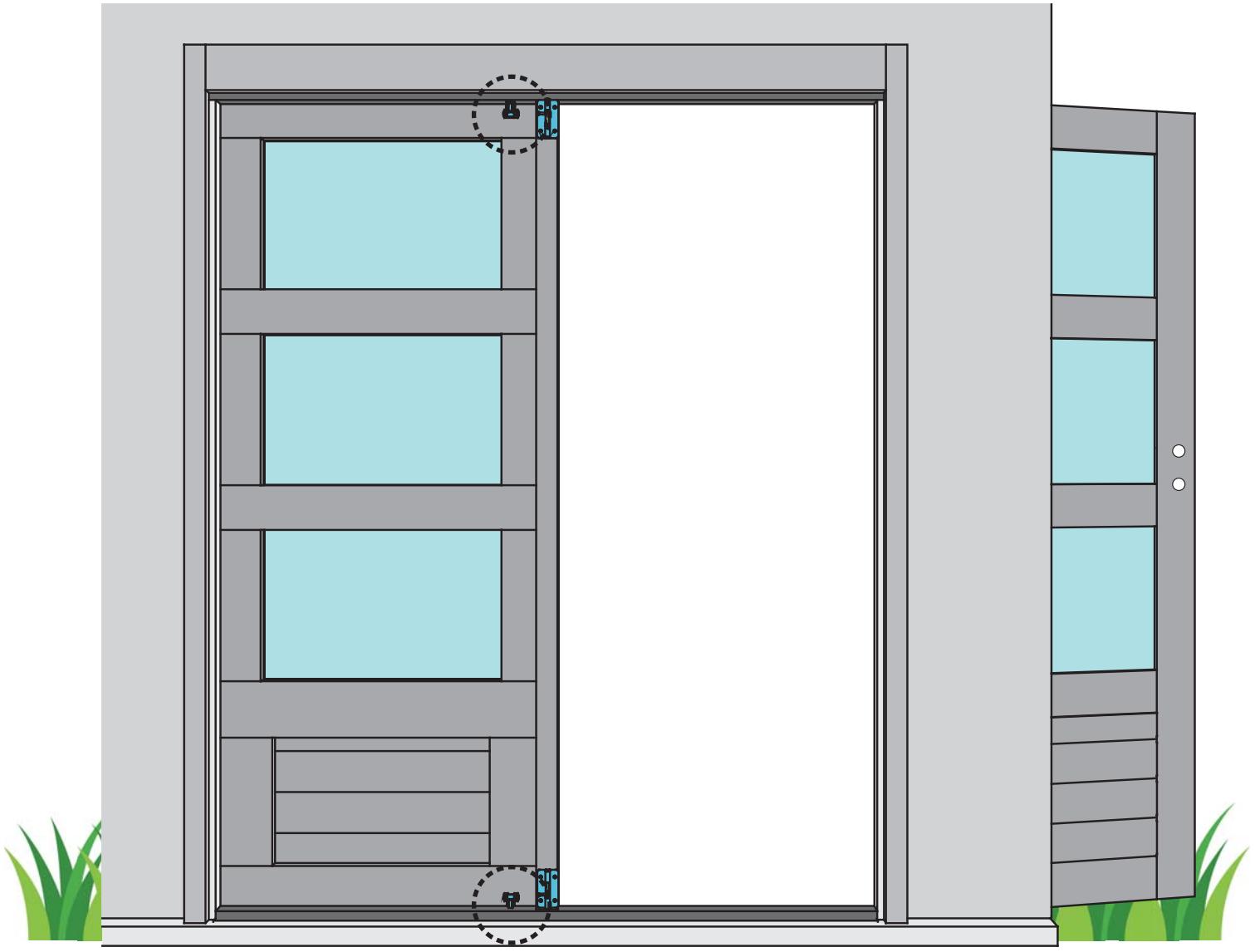
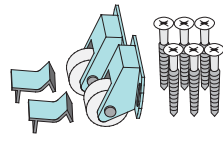



 Türschloss

 Locks

 serrures

 sloten

 Låse

 cabellos

 serrature

 zámky

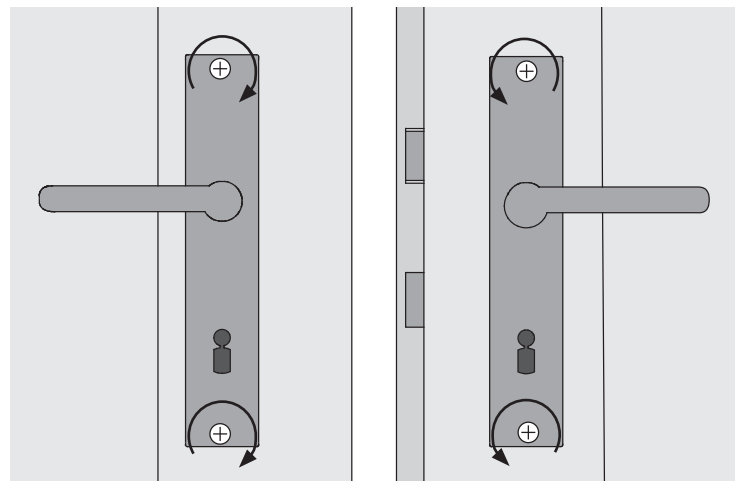
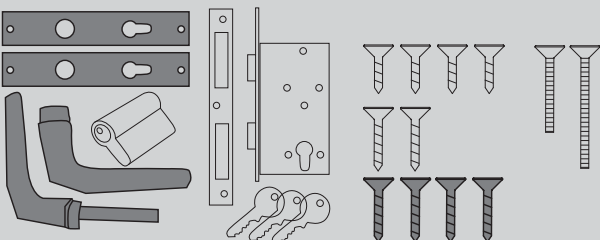
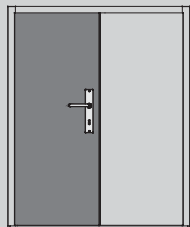
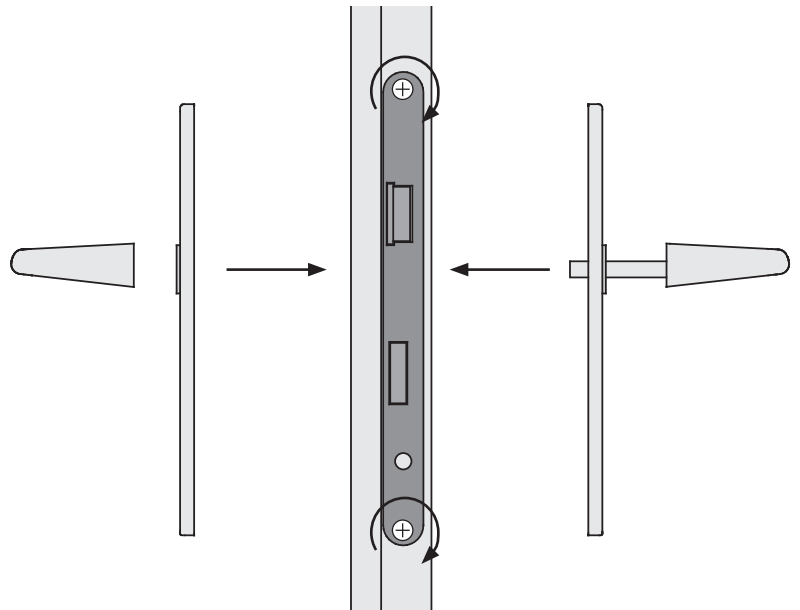
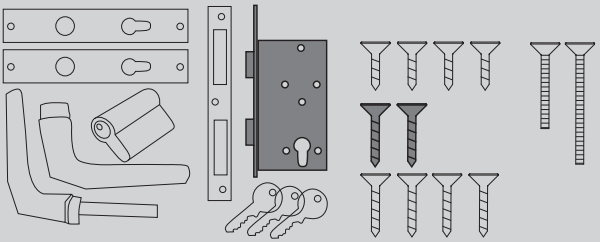
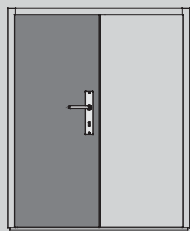
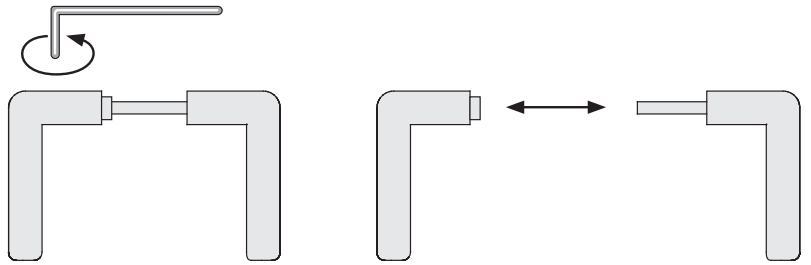
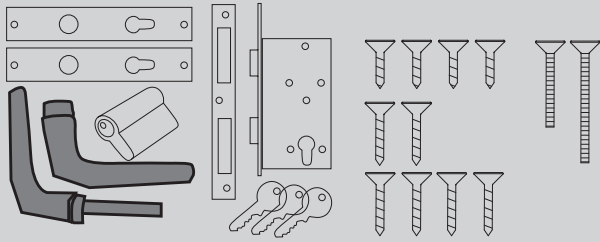
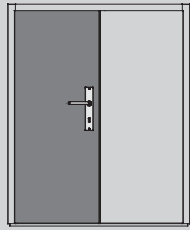

 Türschloss

 Locks

 serrures

 sloten

 Låse

 cabellos

 serrature

 zámky

04

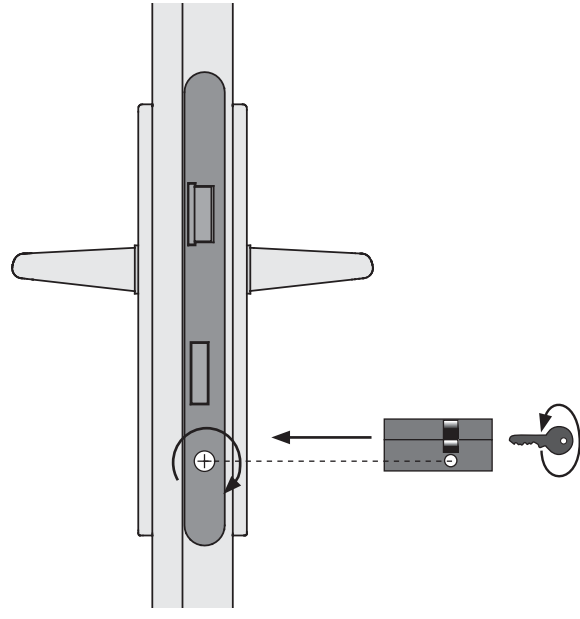
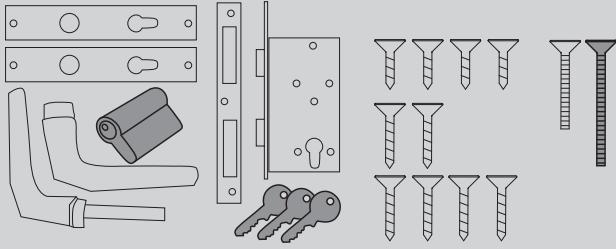
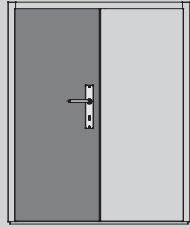

05

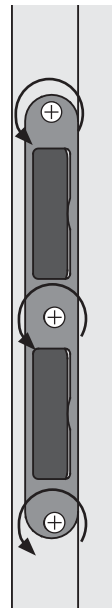
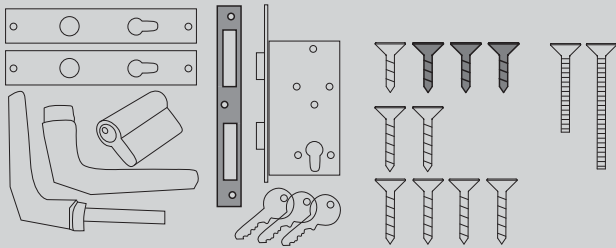
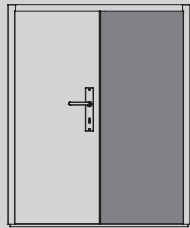

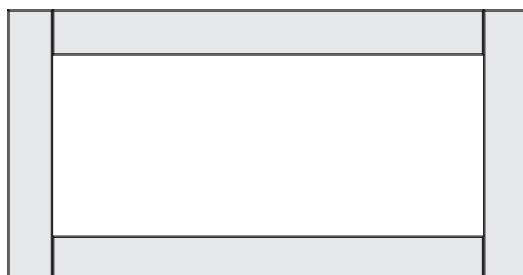

-  **Aufbauanleitung**
-  **Building Instructions**
-  **notice de montage**
-  **montagehandleiding**
-  **Montagevejledning**
-  **Instrucciones de construcción**
-  **Istruzioni per il montaggio**
-  **Montážní návod**

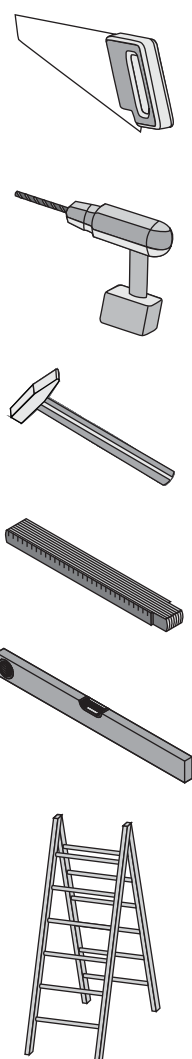

-  Ausschnitt Fenster
-  Cutout window
-  Fenêtre de découpe
-  Uitgesneden venster
-  Udskæringsvindue
-  Ventana de recorte
-  Finestra di ritaglio
-  Okno výřezu

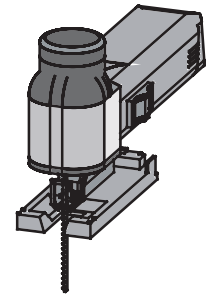
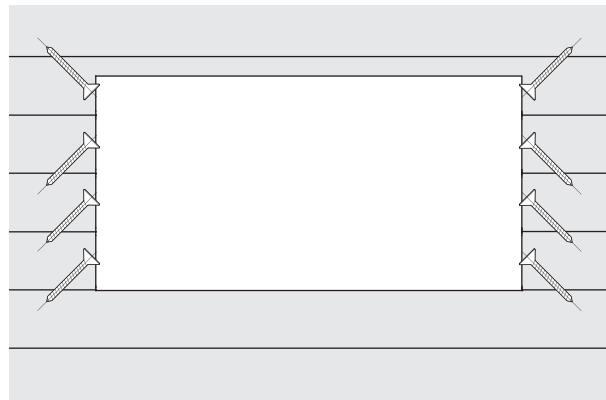
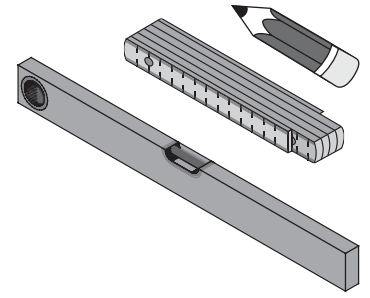
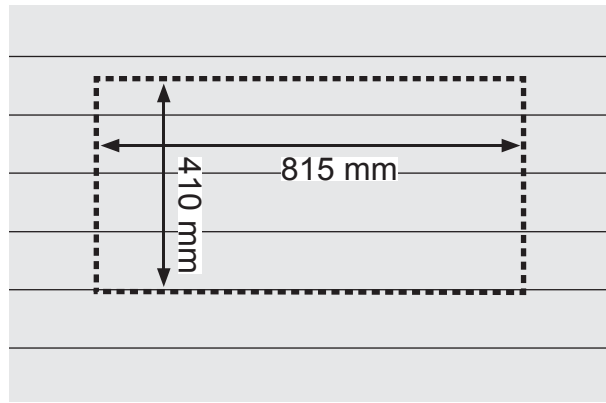
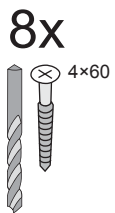



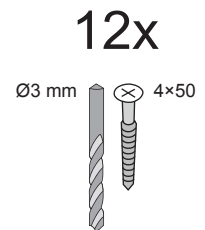
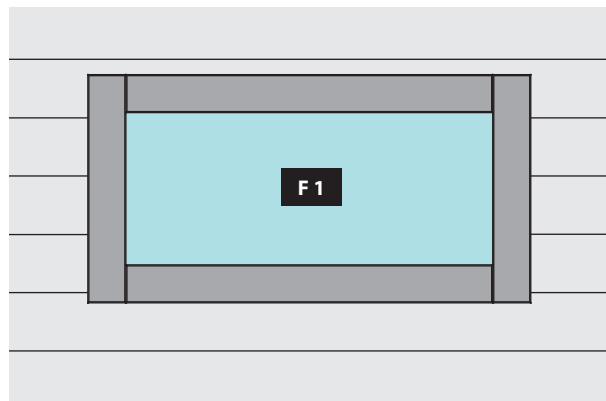

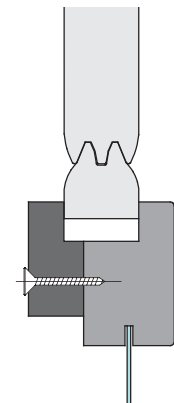
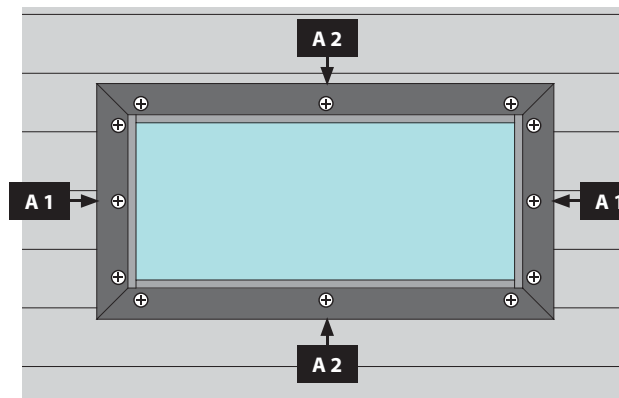

-  außen
-  outside
-  à l'extérieur
-  buiten
-  udenfor
-  fuera
-  al di fuori
-  vně





-  innen
-  Inside
-  à l'intérieur
-  binnen
-  inde
-  dentro
-  dentro
-  uvnitř



 Schutzfolie abziehen
 Remove protective film
 Retirer le film protecteur

 Verwijder de beschermende film
 Fjern beskyttelsesfilm
 Retire la película protectora

 Rimuovere la pellicola protettiva
 Odstraňte ochranný film

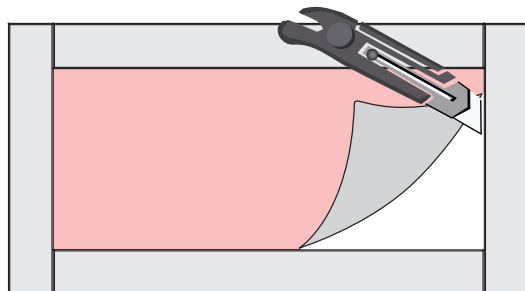

La garantie liée au matériel est subordonnée à son entretien.

Afin d'assurer au matériel un fonctionnement et une valeur durables, une maintenance et un entretien appropriés pendant toute la durée de la garantie sont nécessaires mais ne font pas partie intégrale de la garantie. Il convient de remédier aux anomalies ou aux défauts aussitôt après leur constatation.

Technique de traitement pour la préservation du bois

Les éléments de la porte au complet font l'objet d'une technique de traitement de préservation du bois. Après le montage, certaines parties du bois ne seront plus accessibles. Elles seront par conséquent traitées entièrement avant le montage. Apposer avec une couche d'anti-corrosif sur le bois puis passer deux couches de lasure à pores ouverts pour bois. Repasser une couche de lasure de protection au moins tous les deux ans. Noter qu'une peinture non appropriée pour les panneaux en contreplaqué peut donner ultérieurement une couleur différente de celle des portes. En ce qui concerne les maisonnettes prépeintes et autoclavées, seuls les emplacements où le bois brut apparaît, tels que les parties sciées et les divers éléments, doivent subir un traitement complet. Il suffit de passer une seule couche sur la surface intérieure pour obtenir une couleur homogène. Pour ce faire, il est conseillé d'utiliser une laque à dispersion aqueuse et à pores ouverts à base de résine acrylique. Afin d'assurer au produit une longévité maximum, il est recommandé de réparer immédiatement les parties endommagées qui seront légèrement poncées dans un premier temps puis enduites d'une nouvelle couche de peinture. Renseignez-vous sur les lasures appropriées auprès de votre magasin de peintures. Pour obtenir une longévité maximum de la porte et une optimisation de son imperméabilité contre les intempéries, colmater les espaces entre l'encadrement et la vitre de la fenêtre avec un mastic ou une pâte de colmatage adaptés. Ces mesures d'entretien, si elles ne sont pas appliquées de manière appropriée, peuvent provoquer des déformations, des attaques de corrosion, des attaques fongiques des portes et des encadrements et entraînent la perte de la garantie liée au produit.

Nettoyage

Un nettoyage et un entretien réguliers garantissent une longévité maximum et un excellent fonctionnement des produits de haute qualité. Nettoyer les parois extérieures et intérieures ainsi que les jointures. Les produits de nettoyage doivent être appropriés au matériel à traiter. Vérifier leur compatibilité avant le commencement des travaux.

Déformation de la porte

Le bois réagit sous l'influence de son environnement. C'est ainsi qu'il gonfle et qu'il se resserre selon le temps qu'il fait. Il peut en résulter des variations de proportions et des déformations. C'est pourquoi, afin d'obtenir la fermeture exacte d'une porte, il est nécessaire de procéder à un ajustement de la fixation au cours des changements de saison en enfonçant les fiches vers l'intérieur ou en les dévissant vers l'extérieur. Une déformation des portes est acceptable dans la mesure où son fonctionnement est assuré par les diverses possibilités de réglage décrites ici. Aucun droit de garantie ne sera reconnu en cas de dégâts provenant de manipulations violentes.

Réglage de la porte

Pour obtenir un fonctionnement parfait, la porte doit être assemblée avec précision. L'encadrement doit être assemblé à angle droit et à la verticale. Il doit également présenter la même largeur dans sa partie supérieure et dans sa partie inférieure. Si une porte ne ferme pas ou si un battant est de travers, enfoncer les fiches à visser ou les dévisser légèrement vers l'extérieur (5 rotations sont possibles). Dans le cas d'une porte à deux battants, le battant de verrouillage doit toujours être fixé en haut et en bas avec les ferrures prévues à cet effet.

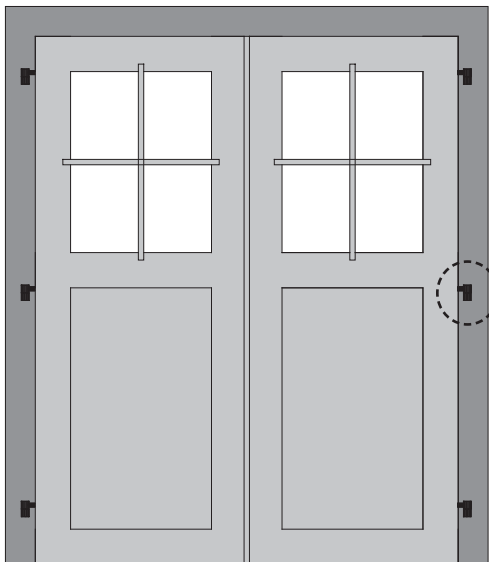

**Fiches à visser
Schroefscharnier**

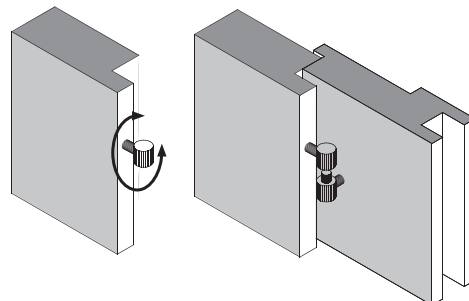

Onderhoud is een voorwaarde voor garantie!

Om de bruikbaarheid en waardevastheid duurzaam te waarborgen, is ook tijdens de garantieperiode deskundig onderhoud noodzakelijk; dit maakt geen deel uit van de garantieverplichting. Defecten moeten onmiddellijk na ontdekking ervan worden verholpen.

Houtbeschermingstechnische behandeling van de deur

Alle onderdelen van de deur moeten altijd houtbeschermingstechnisch worden behandeld. De plaatsen van het hout die later als het huisje is gemonteerd niet meer toegankelijk zijn, dient u vóór het opbouwen volledig te behandelen. Behandel de deur vóór het opbouwen met antiblaauwmiddel, daarna voorzien van een dubbele beschermende coating van ademende houtbeschermende beits. Uiterlijk om de twee jaar dient u de deklaag over te schilderen. Bij de deurtjes moet in acht worden genomen dat de gebruikte platen materiaal in geval van ongeschikte soorten verf kleurafwijkingen t.o.v. de rest van de deurtjes krijgen. Bij geverfde en onder vacuümdruk geïmpregneerde huisjes hoeven alleen de naturel houten onderdelen (zaagkant) en houtdelen te worden nabehandeld. Een gelijkmatig dekkende kleur kan binnen door één keer overschilderen worden verkregen. Gebruik daarvoor een ademende watergedragen dispersielak op acrylharbasis. Om een lange levensduur van uw product te garanderen, dienen beschadigde plaatsen onmiddellijk te worden gerepareerd. Daarvoor de beschadigde plaats licht opschuren en van een nieuwe verflaag voorzien. Informeer naar geschikte beitsen bij uw verfsppecialzaak. Verder kunt u, om een lange levensduur van de deur te waarborgen en de slagregendichtheid te verbeteren, de overgang tussen het hout en de ruiten met een geschikte kit afdichten. Als deze onderhoudsmaatregelen niet oordeelkundig worden uitgevoerd, bestaat het risico van vormveranderingen, blauwheid, schimmelaantasting van de deuren en kozijnen en daarmee verlies van de garantie.

Schoonmaken

Regelmatig schoonmaken en onderhoud is een basisvoorwaarde voor het behoud van de levensduur en de goede werking van hoogwaardige producten. Binnen en buitenkanten alsmede de sponning moeten goed worden schoongehouden. Daarbij moeten de schoonmaakmiddelen zijn afgestemd op het betreffende materiaal, hetgeen vóór het begin van de werkzaamheden dient te worden gecontroleerd.

Vervorming van de deur

hout reageert op omgevingsinvloeden. Zo zal het hout afhankelijk van de weersomstandigheden opzwellen en krimpen. Daardoor treden er maatafwijkingen en lichte vervormingen op. Om ervoor te zorgen dat de deur goed blijft sluiten, moet afhankelijk van de weersgesteldheid de deur door in- en uitschroeven van de scharnieren worden afgesteld. Iets scheefftrekken van de deuren moet worden geaccepteerd zolang de werking door de hier genoemde instelmogelijkheden is gewaarborgd. Voor schade die ontstaat door het toepassen van geweld bestaat geen aanspraak op garantie.

Instellen van de deur

De deur moet nauwkeurig worden afgesteld om goed te kunnen werken. Het deurkozijn moet haaks en loodrecht zijn gemonteerd. Verder moet het frame zo zijn gemonteerd dat het boven en onder even breed is. Als de deur niet sluit of een deurblad hangt scheef, dan kan dit worden gecorrigeerd door de schroefscharnieren iets naar binnen of naar buiten te draaien. Deze scharnieren kunnen max. 5 slagen naar buiten worden gedraaid. Als u een dubbele openslaande deur heeft, moet het vaste gedeelte steeds naar boven toe en met behulp van het daarvoor bedoelde sluitwerk worden vastgezet.

**Exemples de réglage des portes
Voorbeelden voor het instellen van de deuren**

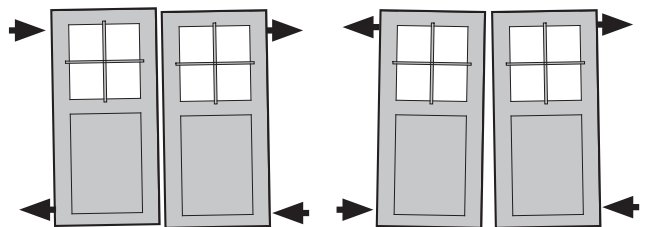



Vedligeholdelse er en forudsætning for en garanti

For den varige forsikring af brugbarheden og varig værdi også i garantiperioden er en professionel vedligeholdelse og pleje påkrævet, hvilket ikke er omfattet af garantibeskyttelsen. Mangler skal udbedres umiddelbart efter opdagelsen.

Træbeskyttelse af døren

Alle dele af døren skal altid behandles med træbeskyttelse. På steder hvor træet ikke længere vil være tilgængelige efter montering skal behandles fuldt ud inden konstruktion påbegyndes.

Behandl produktet med blokerende primer og derefter med en dobbelt gang beskyttende behandling af egnet træbeskyttelse.

Mindst hvert andet år skal overfladebehandlingen gentages.

Bemærk, at de indsatte plader af andet materiale kan komme til at variere i farver i forhold til dørene, hvis du bruger uegnet produkter til behandlingen.

For farvede og trykimprægnerede huse skal kun bruges træbeskyttelse på steder som er blottet til naturligt træ, f.eks. ved savsnit.

Du kan få en jævn farvelægning på indersiden med et lag maling. Hertil skal du bruge en akrylbaseret vanddisperseret lak. For at garantere en lang levetid for dit produkt skal du straks reparere beskadigede områder. Forhør dig altid om passende produkter til træbeskyttelse hos en farvehandler. Desuden kan du forsegle tilslutningen af trævinduet med en passende fugemasse for at sikre en lang levetid på døren og forhindre lækage fra kraftig regn. Hvis disse forholdsregler for pleje ikke udføres korrekt, kan det resultere i deformation, blå skimmel, svampeangreb i dørene og rammer og tab af garanti.

Rengøring

Regelmæssig rengøring og pleje er en forudsætning for at bevare levetiden og funktionaliteten af produkter med høj værdi. Rengøring skal foregå både udvendigt og indvendigt samt også i fals-området. Det anvendte rengøringsmiddel skal være egnet til det relevante materiale. Test venligst, inden du begynder at rengøre.

Deformation af døren

Træ reagerer på miljøpåvirkninger. Vejret eksponering vil føre til hævelse og sammentrækning af træet. Dette medfører variationer af dimensioner og mindre deformation. Afhængig af vejreksponeringen kan døren muligvis tilpasses ved at dreje hængslerne ind eller udad. Krumninger anses for acceptabel, så længe døren kan laves til at fungere gennem de justeringsoptioner, der er specificeret her. Garantien dækker ikke skader forårsaget af brug af overdreven kraft.

Justering af døren

Døren skal indstilles nøjagtigt for at sikre problemfri anvendelse. Dørrammerne skal installeres vinkelret og lodret. Desuden skal de installeres, så rammens bredde er den samme øverst og nederst. Hvis døren ikke lukker eller hvis den hænger skævt, kan det korrigeres ved begrænset ind- eller udadgående drejning af hængslerne. Du kan dreje hængslerne udad med op til 5 rotationer. Hvis du har en dobbeltdør, skal døren, der skal sikres, altid justeres korrekt øverst og nederst med de relevante hængsler.

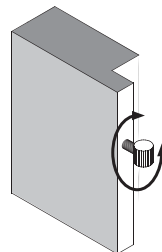
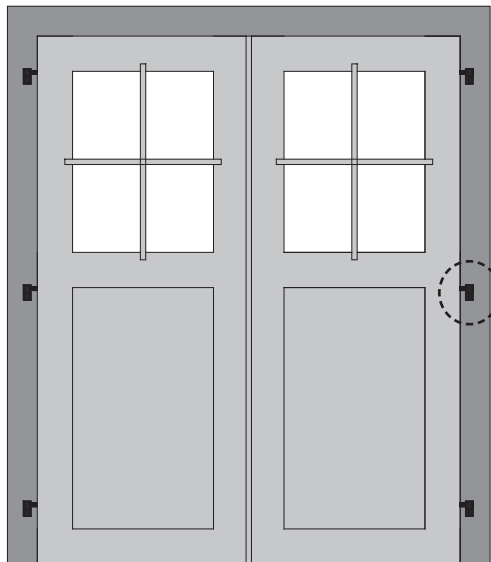

Para cualquier garantía es condición previa que se realice la conservación!

Para asegurar de forma duradera la utilidad y el valor también es necesario que se realice durante el periodo de validez de la garantía el mantenimiento y cuidado apropiados, que no están incluidos en las obligaciones de la garantía. Los defectos deberán ser reparados inmediatamente después de detectarse.

Tratamiento técnico protector de madera de la puerta

Todas las piezas constructivas de la puerta deberán tratarse siempre según la técnica para protección de madera. Aquellas partes o zonas de la madera que, tras el montaje, ya no serán accesibles deberán ser tratadas completamente antes de proceder a su montaje. Trate usted el producto con una imprimación protectora contra el hongo de azuleo, a continuación aplíquelo dos manos de barniz protector de madera de poros abiertos. Como muy tarde cada dos años se debería aplicar de nuevo una mano de protección. En las puertas deberá tenerse en cuenta que las planchas utilizadas pueden presentar variaciones de color, si no se utilizan los materiales de pintura apropiados. En casas de colores e impregnadas por medio de caldera a presión solamente se deberán tratar posteriormente las zonas (cortes serrados) y piezas o partes de madera que se hayan dejado al natural. En el interior se deberá conseguir una cobertura de pintura homogénea mediante la aplicación de una sola mano. A fin de garantizar una larga duración de vida útil de su producto las zonas o partes dañadas se deberán reparar de inmediato. Para ello se lijará un poco las zonas dañadas y se volverá a aplicar pintura. Infórmese sobre los barnices apropiados en su asesor técnico de colores. Para garantizar una larga duración de vida útil de la puerta y para aumentar la impermeabilidad a la lluvia que viene de lado por el viento se deberán sellar las transiciones entre la madera y el vidrio de la ventana con alguna masilla selladora adecuada. Si no se han llevado a cabo correctamente estas medidas de conservación y cuidado, podrán producirse deformaciones, hongos de azuleo y hongos en general en las puertas, bordes y cercos, con lo que se puede extinguir la garantía.

Limpieza

La limpieza y el cuidado periódicos son condición previa básica para mantener la vida útil y la funcionalidad de los productos de alta calidad. También se deberán limpiar las partes interiores y exteriores en la zona de los encajes y las ensambladuras. Los detergentes o agentes limpiadores deberán ser apropiados para cada material en cuestión. Se deberá comprobar la idoneidad de dichos agentes antes de comenzar el trabajo.

Deformación de la puerta

La madera reacciona a las influencias del medio ambiente. Así, según el clima que haga, pueden producirse hinchamientos y encogimientos de la madera. Debido a este fenómeno se producen variaciones o desviaciones de las medidas y dimensiones y, por tanto, ligeras deformaciones. Para mantener la capacidad de cierre de la puerta se adaptará la misma, según las condiciones climáticas y sus repercusiones, girando hacia fuera o hacia adentro los pernios. Se podrá aceptar una deformación de la puerta, siempre que su funcionamiento siga garantizado mediante las posibilidades de ajuste indicadas en las presentes instrucciones. No se asumirá garantía alguna por aquellos daños que hayan sido causados por acción violenta.

Ajustar la puerta

La puerta deberá estar exactamente alineada a fin de que su funcionamiento perfecto esté garantizado. El marco de la puerta deberá estar montado en ángulo recto y perpendicularmente. Asimismo el marco de la puerta deberá estar montado de manera que tenga el mismo ancho arriba que abajo. Si la puerta no cierra o una hoja de la misma está torcida, se podrá corregir roscando o desenroscando un poco los pernios. Estos pernios se pueden desenroscar hasta 5 vueltas. Si tiene usted una puerta de dos hojas, la hoja de retención siempre se deberá fijar tanto arriba como abajo con los herrajes correspondientes previstos para dicho fin.

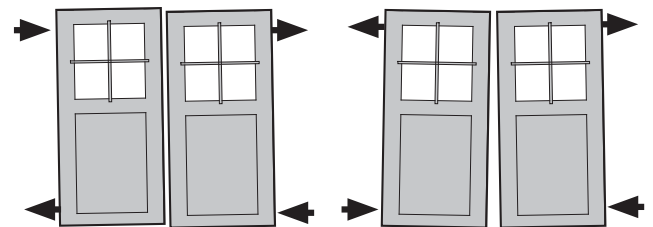

**Eksempel på justering af døre
Ejemplos para ajustar las puerta**

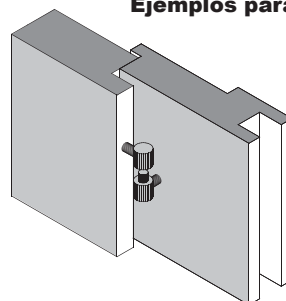

**Hængsel
Pernio de roscar**

Una corretta manutenzione è la premessa per il ricorso alla garanzia

Per garantire l'idoneità all'uso del portoncino e mantenerne inalterato il valore nel tempo, anche durante il periodo della garanzia sono necessarie una manutenzione e una cura adeguate che non sono comprese nell'obbligo della garanzia. Eventuali difetti devono essere corretti subito dopo il rilevamento.

Trattamento protettivo del portoncino

Tutte le parti in legno del portoncino devono essere sempre sottoposte a trattamento protettivo. Prima dell'installazione, è necessario eseguire il trattamento integrale dei punti che successivamente non risulteranno più accessibili. Nel caso venga utilizzato un prodotto contro il turchino, prevedere successivamente l'applicazione di un doppio strato di impregnante per legno a poro aperto. Si consiglia di ripetere l'applicazione dello strato protettivo al massimo ogni due anni. È necessario ricordare che, in caso di utilizzo di vernici non adatte, le placche in plastica inserite potranno presentare delle differenze cromatiche rispetto ai portoncini. Nel caso di edifici colorati e impregnati a pressione, il trattamento successivo interesserà solamente i punti e le parti in legno lasciati al naturale. Una copertura del colore uniforme nell'area interna deve essere raggiunta verniciando una volta la parte interna con una vernice a base di resine acriliche in dispersione acquosa a poro aperto. Per assicurare una lunga durata del prodotto, eventuali punti danneggiati devono essere riparati in modo tempestivo, carteggiando leggermente e applicando nuovamente il colore. Il vostro rivenditore di fiducia saprà consigliarvi degli impregnanti adatti. Per garantire una lunga durata del portoncino e aumentarne la tenuta all'acqua, è inoltre possibile sigillare la giunzione vetrolegno con un'apposita pasta.

Un'esecuzione non corretta delle operazioni indicate può determinare la comparsa di deformazioni, azzurramento e funghi sul legno di porte e telai e il conseguente decadimento della garanzia.

Pulizia

Una pulizia e una cura regolari sono essenziali ai fini della durata e dell'efficienza di prodotti pregiati. La pulizia deve essere effettuata sul lato interno, su quello esterno e anche nella scanalatura nel telaio. Prima di iniziare la pulizia, verificare la compatibilità dei detergenti con il materiale da pulire.

Deformazione del portoncino

Il legno reagisce alle condizioni ambientali. Il rigonfiamento e il ritiro, cui può essere soggetto il legno a seconda delle condizioni atmosferiche, comportano variazioni dimensionali e lievi deformazioni. Affinché il portoncino continui a chiudersi correttamente, può rendersi necessario un intervento sulle cerniere, avvitandole o svitandole, a seconda delle condizioni atmosferiche. Finché il funzionamento viene garantito dalle possibilità di regolazione indicate, la deformazione del portoncino è considerata accettabile. La garanzia non copre danni derivanti dall'uso di forza.

Regolazione del portoncino

Per assicurare il corretto funzionamento del portoncino, lo stesso deve essere posizionato con precisione. Il telaio deve essere incassato in posizione perpendicolare al pavimento e ad angolo retto. Il telaio va inoltre montato in modo da avere la stessa larghezza sia superiormente che inferiormente. Se il portoncino non si chiude o un battente non è ben bilanciato, il problema può essere corretto intervenendo sulle cerniere a vite, avvitandole e svitandole fino a 5 giri. Nel caso di portoncini a doppio battente, il battente fisso deve essere sempre assicurato verso l'alto e verso il basso per mezzo degli appositi meccanismi.

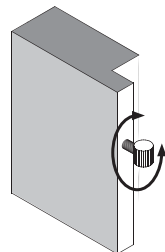
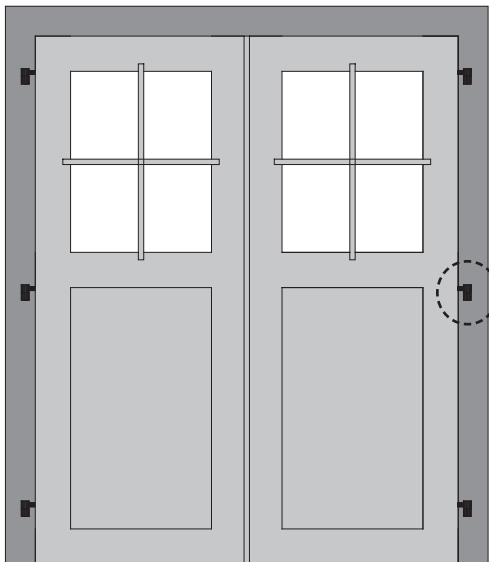

Údržba je předpokladem pro zachování záruky!

Pro udržení trvalé funkčnosti a dobrého stavu je třeba i během záruční lhůty provádět odbornou péči a údržbu, která není zahrnuta v záručních podmínkách. Veškerá poškození musí být ihned po jejich zjištění odstraněna.

Ochranný nátěr dřevěných dveří

Všechny části dveří musí být ošetřeny ochranným nátěrem. Místa, která budou po montáži nedostupná, je třeba ošetřit ještě před montáží. Nejprve ošetřete výrobek nátěrem pro ochranu dřeva proti zamodralosti, následně jej opatřete dvojí vrstvou ochranné lazury s otevřenými póry. Nejpozději každé dva roky byste měli ochranný nátěr nanést znovu. U dveří je třeba dát pozor na to, aby při použití nevhodných nátěrových látek nedošlo k barevným odlišnostem mezi použitými deskami a dveřmi. U barvených a tlakovou impregnační ošetřených domků je třeba ošetřit pouze ty části a díly, které nebyly dosud ošetřeny (např. Vámi provedené řezy). Souvislý barevný nátěr ve vnitřní části získáte jedním natřením. Použijte k tomu disperzní vodou ředitelný lak s otevřenými póry na bázi akrylové pryskyřice. Aby byla zachována dlouhá životnost produktu, měla by být poškozená místa ihned opravena. Poškozené místo byste měli nejprve lehce obrousit a poté znovu opatřit barevným nátěrem. Na použití vhodných lazur se informujte u odborníků. Pro udržení dlouhé životnosti dveří a zvýšení jejich odolnosti proti prudkému dešti je možno utěsnit přechod mezi tabulí skla a dřevem příslušnou těsnicí hmotou.

Pokud nebudou tato opatření řádně provedena, může dojít u dveří a zárubní k deformacím, zamodráním, nebo napadením houbou a tím i ztrátě záruky.

Čištění

Pravidelné čištění a péče jsou základním předpokladem pro udržení dlouhé životnosti a funkčnosti produktu. Je třeba čistit vnitřní i vnější stranu, a stejně tak oblast záhybů. Je třeba používat čisticí prostředky k tomu určené, což je třeba před započítím práce znovu přezkontrolovat.

Deformace dveří

Dřevo reaguje na vlivy okolního prostředí. Tím dochází k bobtnání a vysychání dřeva. Vznikají tak lehké rozměrové odchylky a deformace. Aby byla zachována těsnost dveří, je třeba dveře vyrovnat zašroubováním nebo vyšroubováním závěsů dveří. Pokřivení dřeva je akceptovatelné do té míry, pokud je možno pomocí výše uvedených úprav zaručit jeho funkčnost. Na škody, které jsou způsobeny použitím síly se záruka nevztahuje.

Nastavení dveří

Dveře musí být přesně vyrovnány, aby byla zaručena jejich bezchybná funkčnost. Rám dveří musí být pravouhlý a kolmý. Zároveň musí být rám umístěn tak, aby měl nahoře i dole stejnou šířku. Pokud nelze dveře zavřít, nebo jsou dveře nakřivo, je možné toto upravit zašroubováním nebo vyšroubováním závěsů dveří. Závěsy lze vyšroubovat až o 5 otočení. Pokud máte dvoukřídlové dveře, musí být pevně stojící křídlo vždy nahoře a dole zajištěno aretací.

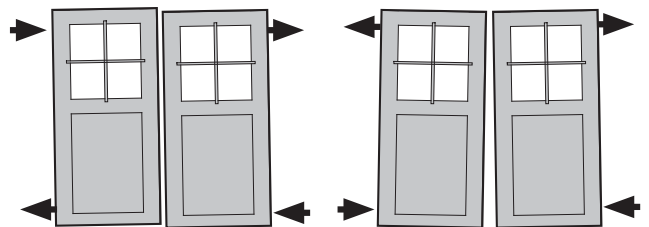

**Esempio di regolazione del portoncino
Příklady srovnání dveří**

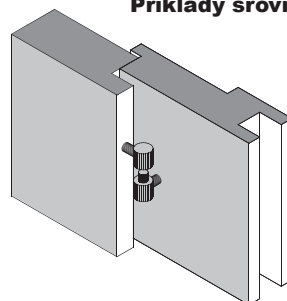

**Cerniera a vite
šroubovatelné závěsy dveří**



Vzdrževanje je pogoj za garancijo

Za trajno zagotavljanje uporabnosti in ohranjanje vrednosti sta tudi med garancijskim obdobjem potrebna strokovno vzdrževanje ter nega, ki ju garancija ne krije. Napake je treba odpraviti takoj po odkritju.

Zaščita lesa vrat

Vsi deli vrat morajo biti obdelani s tehnično zaščito lesa.

Mesta na lesu, ki pozneje zaradi vgradnje ne bodo več dostopna, je treba pred vgradnjo v celoti obdelati.

Izdelek obdelajte s sredstvom proti modri plesni, nato pa z dvojnimi zaščitnim premazom lazure za les z odprtimi porami.

Najmanj vsaki dve leti zaščitni premaz obnovite.

Pri vratih upoštevajte, da se lahko uporabljene plošče pri neprimernih premazih obarvajo drugače od vrat.

Pri barvnih in tlačno impregniranih hišah je treba naknadno obdelati le neobdelane dele lesa (rezi z žago) in lesene kose.

Enakomerno pokrijte z barvo v notranjosti dosežete z enkratnim barvanjem. V ta namen uporabite vodni disperzijski premaz za les z odprtimi porami na osnovi akrilne smole.

Za zagotovitev dolge življenjske dobe izdelka je treba poškodovana mesta takoj popraviti. Poškodovano mesto v ta namen rahlo obrusite in znova pobarvajte. Glede primernih lazur se posvetujte s svojim svetovalcem za barve.

Poleg tega lahko za zagotovitev dolge življenjske dobe vrat in tesnjenja proti dežju prehod med lesom ter okenskimi stekli zatesnite s primernimi tesnilnimi masami. Če teh ukrepov za nego ne opravite strokovno, lahko pride do spreminjanja oblike, modre in drugih plesni na vratih ter podboju in do izgube garancije.

Čiščenje

Redno čiščenje in nega sta pogoj za dolgo življenjsko dobo ter brezhibnost kakovostnih izdelkov. Čistiti je treba zunanjo in notranjo stran, pa tudi območje pregibov. Čistila morajo biti usklajena z materialom, kar preverite pred začetkom dela.

Deformacije vrat

Les se odziva na vplive iz okolja. Zaradi različnih vremenskih vplivov pride zato do nabrekanja in krčenja lesa. S tem prihaja do odstopanj od mer in rahlih deformacij. Da je vrata vseeno mogoče zaklepati, je treba glede na vremenske vplive vrata izravnati z odvijanjem ali privijanjem tečajev. Zamiki vrat so sprejemljivi, dokler je mogoče s tukaj opisanimi nastavitvami zagotoviti delovanje.

Za škodo, ki bi nastala zaradi učinkovanja sile, ne dajemo garancije.

Nastavitev vrat

Vrata je treba natančno izravnati, da je zagotovljeno nemoteno delovanje.

Podboj vrat mora biti vgrajen pravokotno in navpično.

Podboj vrat mora biti poleg tega vgrajen tako, da ima enako širino zgoraj in spodaj.

Če se vrata ne zapirajo ali visijo, lahko to popravite z manjšim privijanjem ali odvijanjem vijačnih tečajev. Te tečaje lahko odvijete za do 5 obratov. Če imate dvokrilna vrata, morate fiksno krilo vedno najprej zapahnniti na zgornjem in šele nato na spodnjem okovu.

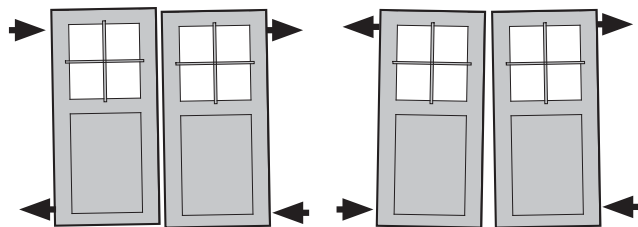
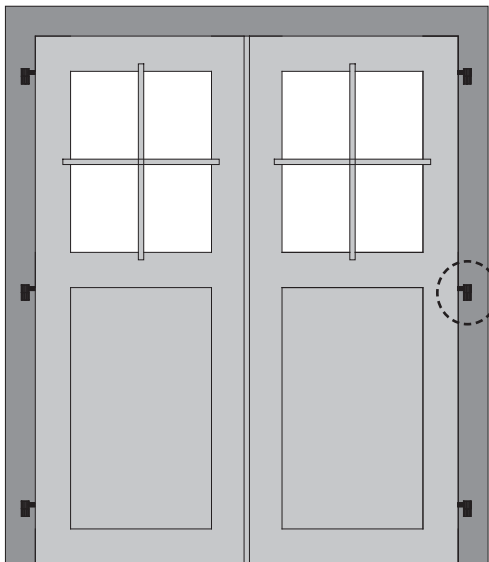

Eksempel på justering af døre
Ejemplos para ajustar las puertas

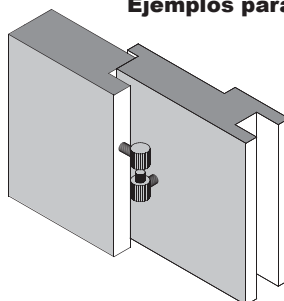
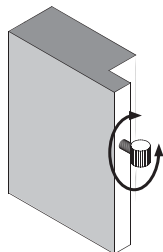

Hængsel
Pernio de rosca